



An IoT Framework for Real Time Water Quality Check and Level Observation System

Jijesh J J^{1*}

¹Professor, Department of Electronics and Communication Engineering, Sri Venkateshwara College of Engineering, Bangalore, Karnataka. Email: jijesh_jj@yahoo.co.in

Dileep Reddy Bolla²

²Associate Professor, Department of Computer Science Engineering, Nitte Meenakshi Institute of Technology, Bangalore, Karnataka. Email: dileep.bolla@nmit.ac.in

Lakshmi Manasa B³

³Assistant Professor, Department of Electronics and Communication Engineering, Sri Venkateshwara College of Engineering, Bangalore, Karnataka. Email: manasa.7006@gmail.com

Niranjana C⁴

⁴Assistant Professor, Department of Electronics and Communication Engineering, Sri Venkateshwara College of Engineering, Bangalore, Karnataka. Email: niranjana3194@gmail.com

Sruthi P V⁵

⁵L&T Technology & Services, Bangalore, Karnataka. Email: sruthi.38@gmail.com

Meghavarshini S K⁶

⁶Assistant Professor, Department of Electronics and Communication Engineering, Sri Venkateshwara College of Engineering, Bangalore, Karnataka. Email: meghakgowda988@gmail.com

Prakasha G⁷

⁷Assistant Professor, Department of Electronics and Communication Engineering, Sri Venkateshwara College of Engineering, Bangalore, Karnataka. Email: prakasha.g_cse@svcengg.edu.in

ABSTRACT

Nowadays the monitoring of water quality has become an essential need with usage of various technologies for a better living. Internet of Things (IoT) is networks of smart devices that can sense the environment and exchange data using the internet through interfaces. Because of the expanded level in water contamination, customary strategies for checking and keeping up the nature of water turn into a noteworthy test. In this regard, implementation of real time framework using node microcontroller unit (MCU) to check and maintain the quality of water by measuring the parameters such as turbidity, pH (Potential of Hydrogen) level, temperature, and dissolved oxygen content using IoT technology for maintaining the water quality as well as water level is introduced. Finally an alert message regarding water quality will be given to the concern by using Cloud services (Adafruit). The developed prototype helps in testing water samples and the information can be uploaded using the internet to the cloud, and from cloud to the concerned person or authority.

Keywords: IoT, Water quality check, Turbidity, pH, Adafruit.

1.0 Introduction

Water has acquired an endless worth in the new past. This situation emerges mostly in the different appearances. Populace, maturing infrastructure, haggard innovations, and ground water defilement have been the front sprinters of the many difficulties that water faces. Only 2% of total volume of fresh water is available for human consumption. Of the numerous ecological difficulties, the most squeezing is the

quality and accessibility of natural water assets, however there are not many regions containing consumable water that contamination has left unadulterated for monitoring. The water is limited and essential for industry, agricultural activities, and all the living beings. The main causes of water pollution are industrialization, agriculture fertilizers and non-enforcement laws led to water pollution to a larger extent [1]. These days water quality observation continuously faces challenges as a result of an Earth-wide temperature boost, restricted water assets, developing populace, and so forth. Hereafter, there is an urgency in developing better techniques to screen the water attribute specifications progressively [2]. Due to increased water pollution as shown in Fig.1, various water parameters for instance turbidity, Potential of Hydrogen and temperature should be monitored accurately. Monitoring water quality is essential for protecting aquatic ecosystems and maintaining biodiversity. It helps assess the health of rivers, lakes, oceans, and other water bodies, and identify any negative impacts caused by pollution or other human activities. Monitoring can detect changes in water quality, enabling early intervention and remediation measures to protect fragile ecosystems, aquatic life, and overall environmental balance.

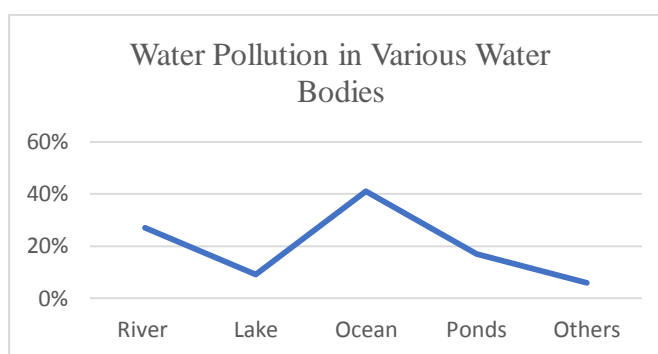

Fig. 1 Water Pollution in various water bodies

The water quality attributes pH shows alkalinity of water. Pure water got pH value 7, less than 7 values indicate acidity and more than 7 indicate alkalinity. The normal range of pH is 6.5 to 7.5. In drinking water if the typical scope of pH doesn't keep up it makes the bothering the eyes, skin and mucous films. Likewise, it causes the skin issue. The broke down oxygen is demonstrated the oxygen that disintegrated in water. It enhances taste of drinking water. The disintegration of water assets turns into a typical human issue. The conventional strategies for water quality screen include the manual accumulation of water test from various areas. These water tests tried in the research center utilizing the scientific advances [4]. Such methodologies are tedious and never again to be viewed as proficient. In this manner, there is a requisite for non-stop examination of water quality attributes progressively. By centering the above issues, comes the need to create and plan an easy water quality observing framework that can screen water quality progressively utilizing the IoT environment. The prepared information can be checked through a program application. Moreover, with the assistance of the IoT environment, offices also get provision to screen the data from a distance from wherever all through the world. By regularly analyzing various parameters, such as turbidity, pH, dissolved oxygen, and nutrient levels, treatment processes can be adjusted accordingly. This ensures effective removal of contaminants and improves the efficiency of water treatment, leading to better-quality drinking water. [13, 14].

In section II, related existing works of the proposed system are explained; in section III system design considerations are discussed. In section IV methodology of the proposed system and corresponding implementation is given. In section V results of the proposed system are discussed.

2.0 RELATED WORK

The methodology [2] had described an IoT based water quality examination system that identifies the nature of water progressively. This framework comprises a couple of sensors which monitors the water quality parameter, for instance, pH, turbidity, conductivity, separated oxygen, temperature. The deliberate values from the sensors are processed by microcontroller and these are transmitted using a remote profound controller that is a raspberry pi using ZigBee. At last, sensor information is viewed on websites utilizing cloud computing. The major impact with this system is high cost.

In this paper [3] the author had described the requirement for a water tank is essentially as old as civilization, giving capacity of water for drinking water, water system agribusiness, fire concealment, horticultural cultivating, both for plants and domesticated animals, synthetic assembling with numerous different applications. Water tank boundaries incorporate the general plan of the tank, and decision of development materials. Also, described on water checking frameworks, for example, Tank water level detecting observing, water contamination observing and water pipeline spillage detecting observing. By utilizing WSN they maintained a strategic distance from the colossal measure of water which is squandered by unbounded requirements in flats/workplaces. The microcontroller (PID) based Water level checking is implemented to demonstrate the level of water in the tank to the administrator.

In sensor based Water Pollution detecting system, it will take a look at the water quality by utilizing these values, for instance, the pH level, turbidity and temperature are evaluated dynamically by the sensors and it will be seen by an administrator.

3.0 SYSTEM DESIGN CONSIDERATION

In system design, firstly parameters such pH, Turbidity, Water level etc. are measured by using sensors. These calculated values are processed by the microcontroller unit and stored in the cloud and can be encroached by the user by using cloud services. This combination of hardware and software makes implementation more appropriate for real time and is cost effective. The first section describes hardware components required for implementation and in the next section software requirements are explained.

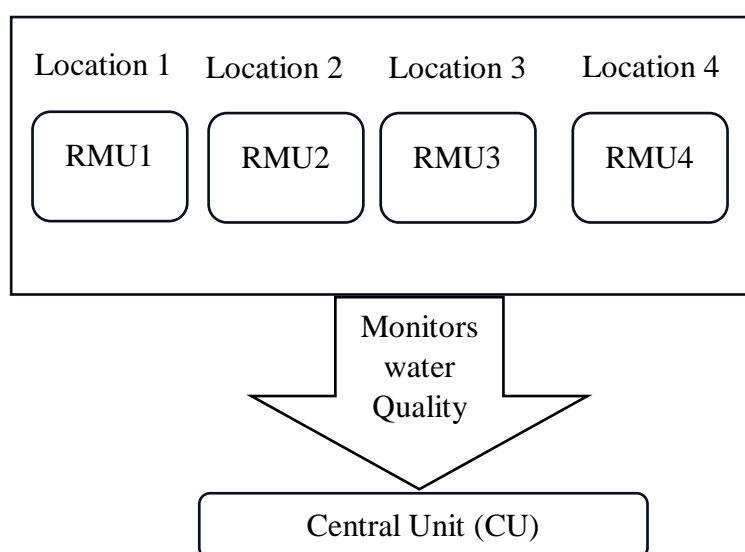

Fig.2: Remote Monitoring Unit (RMU) and Central Unit (CU)

The proposed model as depicted in fig.2 consists of remote monitoring units in different locations. The water quality information can be monitored from RMUs and this information is given to CU, and preventive measures are taken accordingly.

3.1 HARDWARE REQUIREMENTS

3.1.1 Turbidity Sensor

Turbidity sensor measures the cloudiness or clarity of water [9]. It is caused by solids that are sinking in water.

TABLE I: Status of Immune system based on NTU Values

NTU Values	Status of Water
< 1 NTU	Good
1 - 5 NTU	Fair
> 5 NTU	Poor

The surface water temperature can be increased due to this turbidity, because of particles that absorb heat 3 - 5 Nephelometric Turbidity Units (NTU) turbidity value is great for older individuals with compromised immune systems as shown in Table I. The turbidity sensor is as depicted in fig. 3.

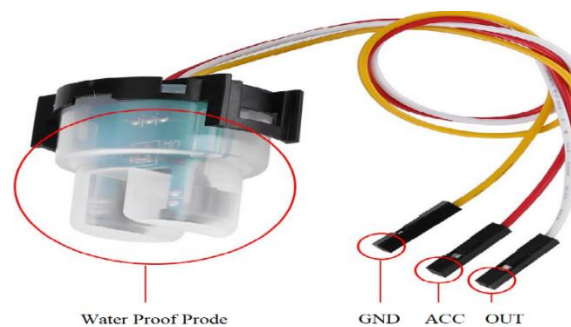

Fig.3: Turbidity sensor

3.1.2 Temperature Sensor

The temperature sensor shown in fig.4 is typically a thermocouple utilized to determine temperature through an electrical signal. A temperature sensor measures the hotness or coldness of water [8]. The sensor works based on the voltage that is read across the resistor. The temperature increases as voltage increases. The sensor records any voltage drop between the input and output of the non-inverting amplifier. The expression to encounter the output voltage is

$$V_{out} = \left[1 + \left(\frac{R_f}{R_1} \right) \right] * V_{in} \quad (1)$$

Where V_{in} is sensor output, V_{out} is amplified value of the sensor output, and R_1 & R_f resistors of the non-inverting amplifiers.

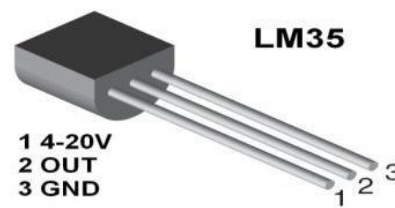

Fig. 4: Temperature Sensor

$$Temp = (5.0 * analogRead(tempPin) * 100.0) / 1024 \quad (2)$$

3.1.3 pH Sensor

The pH is an essential restricting concoction factor for sea-going life. A pH meter is a device that calculates the alkalinity in water and other solutions. pH is measured on a scale with 1 to 14 values. If pH is less than 7, it is acidic or if it is within 7 to 14 represents water as the base. The pH scale is logarithmic, implying that as you go up and down the scale, the values change by a factor of ten [5]. A change in the pH meter indicates the strength of the acid or base in the water. pH sensor is depicted in below Fig. 5.



Fig.5: pH sensor

3.1.4 Water Level Sensor

Water level or float sensor is utilized to quantify or estimate the level of the water in tanks which is shown in Fig.6.



Fig.6: Water level floats Sensor

3.1.5 Node MCU (ESP8266-Microcontroller)

Node MCU is a microcontroller that is connected to a server through the internet. The Micro Controller Unit will receive the ON - OFF packets from the server and switch appliances with respect to

server signal. It gives the capacity to embed Wi-Fi abilities inside different frameworks, or to work as an independent application, with ease and minimum space.



Fig.7: Node MCU

ESP8266EX offers an entire and independent Wi-Fi organizing arrangement; it can be used to have the application or to offload Wi-Fi limits from another application processor. ESP8266 Wi-Fi has to be configured to send information over the internet as shown in Fig.7 [6].

3.2 SOFTWARE REQUIREMENTS

3.2.1 Adafruit

Adafruit IO is a system that makes information valuable. Our focus is on usability and allowing simple connections with little coding required. I/O includes client libraries that cover REST and MQTT Application Programming Interfaces. ADA fruit platform is depicted in Fig. 8, which gives information about parameter fields to be considered for uploading into the cloud for further processing.[7]

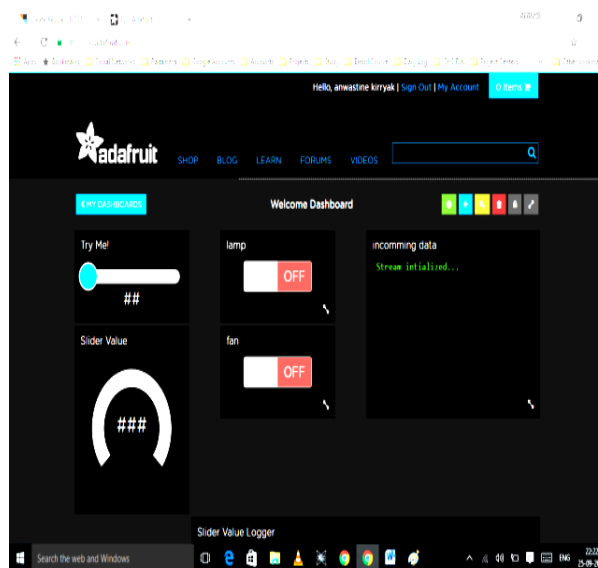

Fig.8: ADA fruit platform

4.0 METHODOLOGY AND IMPLEMENTATION

The main concept behind this paper can be described in a simple block diagram shown in the Fig.9 showing the setup with the sensor and the microcontroller board. The workflow has been shown in Fig. 10.

In this system water quality conditions and water level monitoring can be done through various sensors and Node MCU Controllers [11]. Then data is uploaded to the cloud and clients can get this information from a portable PC.

There are sensors that are used to check the quality of the water and quantity of the water [16]. Turbidity and pH sensors are used to find the quality of the water and the water level sensor is used to monitor the level of the water.

When the water level is exceeded the maximum limit then the relay switching system turns off and the water pump motor will turn off.[15]

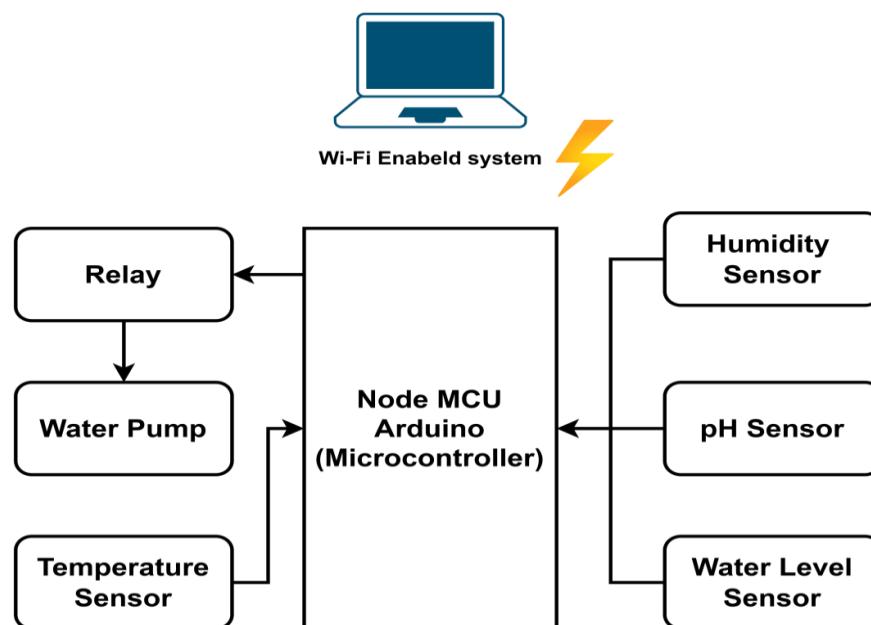

Fig.9: Model of designed RMU with IOT system.

4.1 WORKING FLOW CHART OF WATER MONITORING AND LEVEL OBSERVATION

The flowchart shown in fig. 10 describes the interfacing of the software and the hardware components of the required system to measure various parameters and upload the data to the required server.

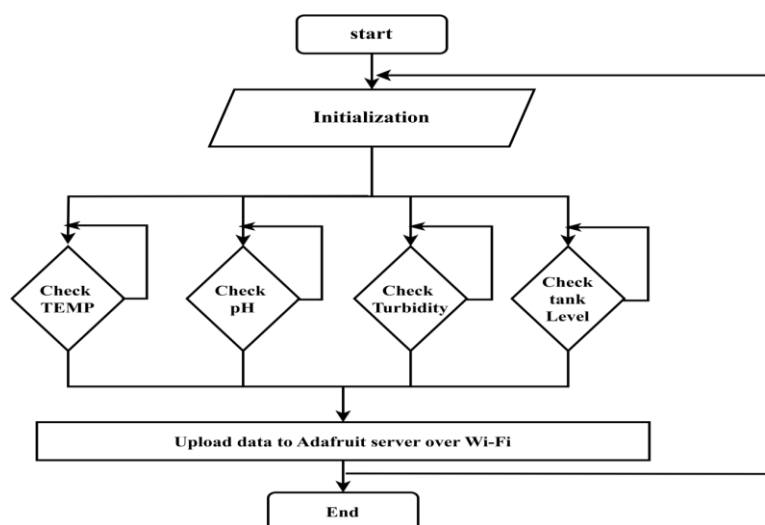

Fig. 10: Workflow of designed system

Water quality conditions and water quality monitoring [10] can be done through various sensors and then all the measured data is uploaded to the cloud and users can access this data from mobile or PC. Initially, the experimental setup for measuring the quality and quantity of water is done through various sensors such as pH, turbidity, and float sensors. These values are processed by the Arduino microcontroller to store in the cloud so that the user can access them.

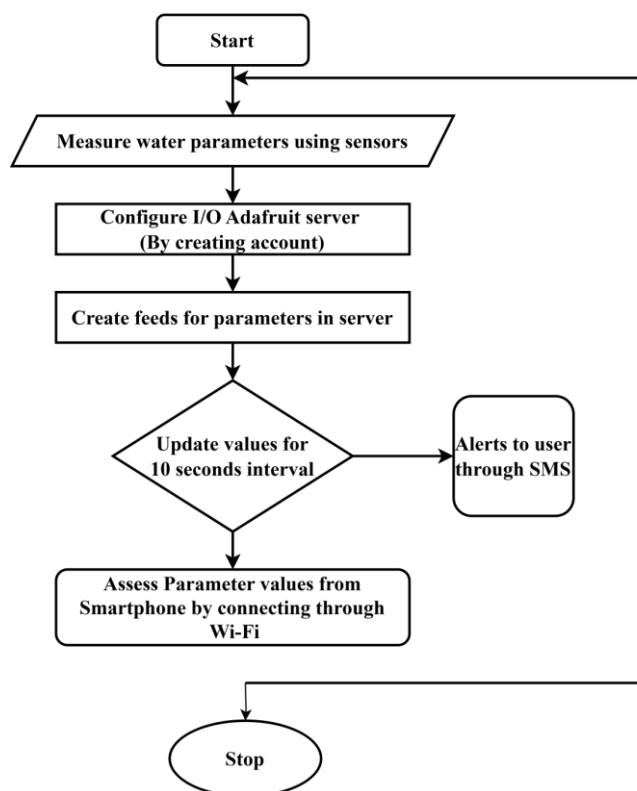

Fig.11: Flow chart of working method

A wireless water level controller using Bluetooth technology is proposed by Suraj et al.[11].To access the cloud firstly configuration of I/O adafruit sensors is to be done. Each parameter should be stored in separate feeds. Every 10 seconds the values are updated. These parameter values can be conveyed to the user by SMS or they can be accessed in the cloud by connecting to Wi-Fi or ZigBee [12]. This complete flow of work is shown in Fig. 11.

5.0 RESULTS AND DISCUSSION

The IoT becomes the future technology for controlling the devices through internet.

Hence a proficient framework has been intended to quantify the nature of the water that can be connected to Adafruit Cloud so that water level can be monitored from mobile or PC.

The system is efficient in terms of measuring pH levels, turbidity levels etc so that proper action can be taken for better water quality and additionally water level can also be measured. Designed system is shown in below figure 12 and 13.

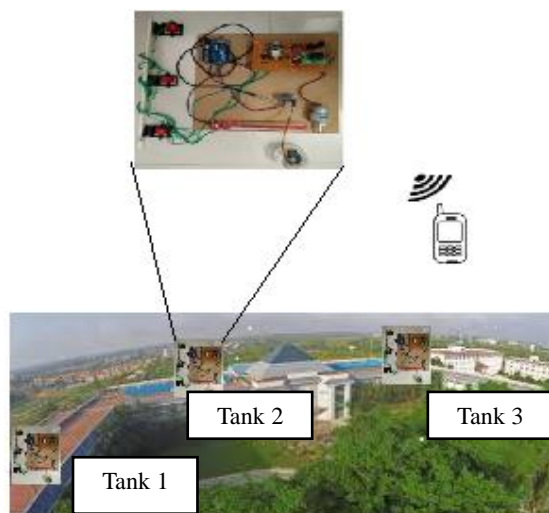

Fig.12: Practical scenario of the proposed system

The practical scenario of the proposed system arrangement has been depicted which has three tanks with RMUs and corresponding parameters are sent to the concerned persons or authorities through the internet.

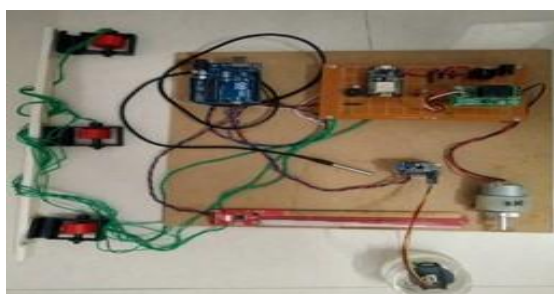

Fig.13: A designed system for water quality and level measurement.

The three test conditions for measuring real-time data pH, Turbidity, Temperature, and water Level have been completed.

Experimental values are tabulated and are sent to the Cloud using a Wi-Fi module which is connected to the internet and are sent to the user for monitoring the water quality and quantity. The following cases are to be considered for table comparisons.

Case1: Performing Water testing upon adding contaminants.

Case 2: Testing temperature upon heating water.

Case 3: Performing Water Level Monitoring.

TABLE II: pH and Turbidity values for 2 sample cases

Parameters	Sample 1	Sample 2 (Heated Water)
Temperature (In ⁰ Celsius)	25 ⁰	30 ⁰

TABLE III: Temperature values of different samples

Parameters	Sample-1 (Tap Water)	Sample-2 (Contaminated water)	Standard Range	Units
pH	6.75	7.5	6.5-8.5	pH
Turbidity	8	5	5-10	NTU

TABLE IV: Tank level monitoring values

S3	S2	S1	Values	Tank Level	Message to user
OFF	OFF	ON	001	LOW	Switch ON Motor
OFF	ON	ON	011	MEDIUM	Half Tank
ON	ON	ON	111	HIGH	Tank Full. Switch OFF

Tabulated values are stored in the cloud which is accessed by the user for remote sensing. The adafruit cloud is chosen among Thingspeak, ubidots etc. for the proposed framework.

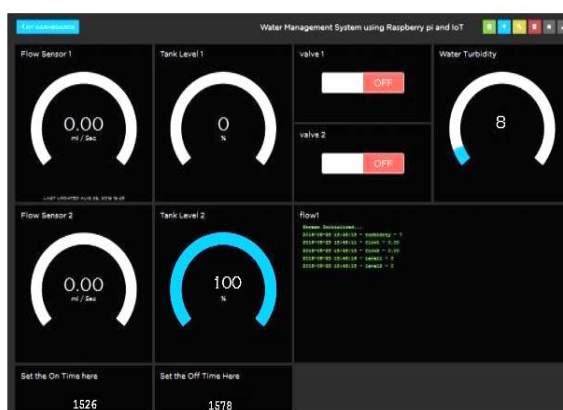

Fig. 14: Adafrit cloud

Water turbidity and tank level are stored in adafruit cloud through the Wi-Fi module. These values are analyzed and alerts are given to the user's smartphone by accessing the cloud which is shown in Fig. 14. In adafruit to monitor each parameter, feeds have to be created and further an SMS alert is sent to mobile for notification to update the information to the user as shown and the messages are displayed in Fig.15.

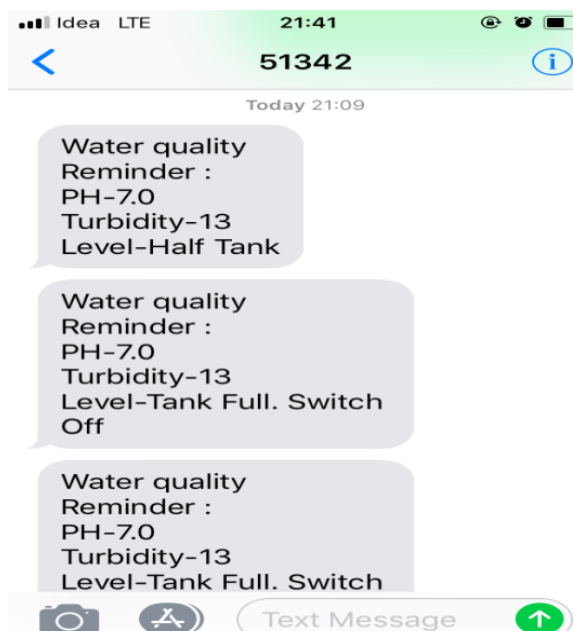

Fig.15: Alert message to be sent to user

As per detailed analysis, various sensor parameters such as pH value, turbidity, and temperature are measured by adding contaminants to water in mg and graphs are plotted for pH values and turbidity which are shown in Fig. 16 and 17.

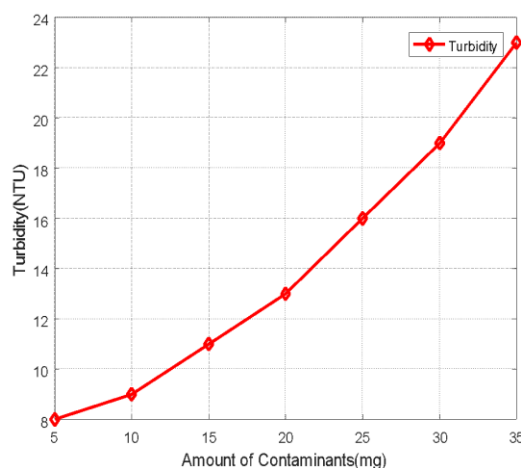

Fig.16: Turbidity (NTU) values

The amount of contamination increases in water then Turbidity values will be increased as depicted in Fig. 16.

The amount of contamination increases in water correspondingly to the acidic nature of the water increases in terms of pH value and as shown in Fig. 17.

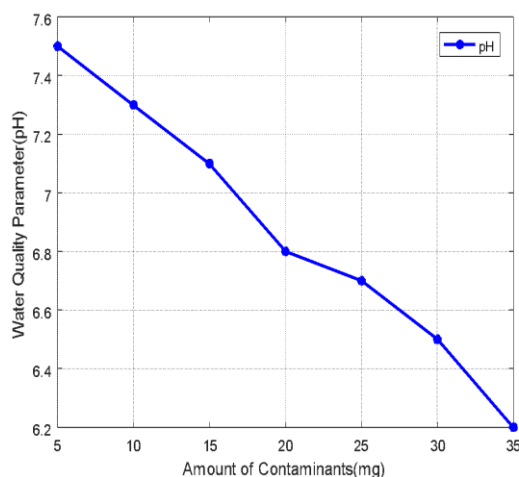

Fig.17: Potential of Hydrogen measured values

6.0 CONCLUSION AND FUTURE SCOPE

An efficacious adaptive water quality and water quantity monitoring system have been proposed to ensure the safety of drinking water by using sensors and cloud models. Sensors sense the level of water and transmit remotely to the controller thereby users can be alert by getting notifications. The quality of water can be measured effectively by this system. To give accurate and timely information to users who are depending upon the authorized water plant by identifying parameters for quality assurance of water. Further enhancement can be done by adapting various sensors for accurate quality of water such as suspended soils, redox potential, Biological Oxygen Demand (BOD), and so on. As per the detailed analysis carried out with various technologies and tools on the water quality system, it is clear that the cost complexity and impurities can be monitored and reduced. Some of the improved algorithms can be incorporated for the detection of water quality which can be the extension of this work.

References

1. SGeetha, S Gouthami "Internet of things enabled real time water quality monitoring system", *Smart Water*, Vol.2, No.1, pp. 2-19, 2017.
2. Jayti Bhatt, JigneshPatoliya, "IoT based water quality monitoring system" *International Journal of Industrial Electronics and Electrical Engineering*, Vol.4, No.4, pp.44-48, 2016.
3. Ms. T. Deepiga, Ms. A. Sivasankari, "Smart Water Monitoring System Using Wireless Sensor Network at Home/Office", *International Research Journal of Engineering and Technology*, Vol.2, No.4, pp.13015-1314, 2015.
4. B. Das and P. C. Jain, "Real-time water quality monitoring system using Internet of Things," *2017 International Conference on Computer, Communications and Electronics (Comptelix)*, Jaipur, 2017, pp. 78-82.
5. Pradeep kumar M , Monisha J, Pravenisha R, Praiselin V, Suganya Devi K, "The Real Time Monitoring of Water Quality in IoT Environment", *International Journal of Innovative Research in Science, Engineering and Technology*, Vol. 5, No. 3, pp.4419-4427, 2016.

6. Manpreet Khurana, Rajesh Kaur, Anshuman Singh, Rohit Prakash, Chhabra, "An IOT Based Water Health Monitoring System", *International Journal of Computer Technology and Applications*, Vol. 9, No. 21, pp. 07-13, 2016.
7. G. Wiranto, G. A. Mambu, Hiskia, I. D. P. Hermida and S. Widodo, "Design of online data measurement and automatic sampling system for continuous water quality monitoring," *2015 IEEE International Conference on Mechatronics and Automation (ICMA)*, Beijing, 2015, pp. 2331-2335.
8. Vaishnavi V. Daigavane, Dr. M.A Gaikwad, "Water Quality Monitoring System Based on IOT", *Advances in Wireless and Mobile Communication*, Vol. 10, No. 5, pp. 1107-1116, 2017.
9. R.Karthik Kumar, M.Chandra Mohan, S.Vengateshapandiyan, M.Mathan Kumar, R.Eswaran, "Solar based advanced water quality monitoring system using wireless sensor network", *International Journal of Science, Engineering and Technology Research*, vol. 3, Issue 3, pp. 385-389, 2014.
10. A. S. Rao, S. Marshall, J. Gubbi, M. Palaniswami, R. Sinnott and V. Pettigrovet "Design of Low-cost Autonomous Water Quality Monitoring System", *2013 International Conference on Advances in Computing, Communications and Informatics (ICACCI)*, pp. 14-19, 2013.
11. S. Suraj, V. Bharath and N. K. Sridhar, "Wireless Automatic Water Level Controller," *2018 International Conference on Electrical, Electronics, Communication, Computer, and Optimization Techniques (ICEECCOT)*, Mysuru, India, 2018, pp. 495-500.
12. Peng Cheng, Xi-Li Wang, "The Design and Implementation of Remote-sensing Water Quality Monitoring System Based on SPOT", *Second IITA International Conference on Geo science and Remote Sensing*, pp. 6-10, 2010.
13. J. J. Jijesh, Shivashankar, L. Rashmi, S. Jayashree, S. kiran A and S. Shreyas, "Design and Development of Intuitive Environment with Health Monitoring System Using Internet of Things," *2018 3rd IEEE International Conference on Recent Trends in Electronics, Information & Communication Technology (RTEICT)*, 2018, pp. 1351-1355, doi: 10.1109/RTEICT42901.2018.9012157.
14. N. Kedia, "Water quality monitoring for rural areas- a Sensor Cloud based economical project," *2015 1st International Conference on Next Generation Computing Technologies (NGCT)*, Dehradun, 2015, pp. 50-54.
15. Preeti Meghwani, Kiran Dewangan, "Real Time Water Quality Monitoring and Control System", *International Journal for Research in Applied Science & Engineering Technology*, Vol.5, No.9, pp.1-3, 2017.
16. Jijesh, J. J., et al. "Design and Implementation of Smart Livestock Security System." *2023 International Conference on Distributed Computing and Electrical Circuits and Electronics (ICDCECE)*. IEEE, 2023