



## ENSEMBLE DIVERGENCE FREE MAXIMUM POWER POINT TRACKING TECHNIQUE UNDER THE INFLUENCE OF PARTIAL SHADING FOR PHOTOVOLTAIC SYSTEM

Aarti S.Pawar<sup>1</sup> Nilkanth B.Chopade<sup>2</sup> Mahesh T.Kolte<sup>3</sup> Hrishikesh Mehta<sup>4</sup>

1- Department of Electronics and Telecommunication, Pimpri Chinchwad College of Engineering, Pune., Savitribai Phule Pune University, Pune, India , [aarti.pawar@pccoepune.org](mailto:aarti.pawar@pccoepune.org).

2- Research Centre, Department of Electronics & Telecommunication Engineering, Pimpri Chinchwad College of Engineering Savitribai Phule Pune University, Pune, India.  
[nilkanth.chopade@pccoepune.org](mailto:nilkanth.chopade@pccoepune.org)

3- Research Centre, Department of Electronics & Telecommunication Engineering, Pimpri Chinchwad College of

Engineering, Savitribai Phule Pune University, Pune, India [mahesh.kolte@pccoepune.org](mailto:mahesh.kolte@pccoepune.org)

4- Research & Development, Aethertec Innovative Solutions, Pune, India [mehta.hrishi@gmail.com](mailto:mehta.hrishi@gmail.com)

---

### Abstract—

This study offers a pervasive maximum power point tracking (MPPT) technique to increase the reliability of the perturb & observe (P & O) maximum power point tracking method under various partial shadow circumferences. The capacity of the PV system to capture maximum power via maximum power point tracking is impeded mostly by partial shadow. Several MPPT strategies based on bio-inspired optimisation methodologies have been reported in the literature. Traditional perturb and observe methods include flaws such as steady-state oscillations, poor tracking performance, incorrect tracking directions, and power loss. The techniques of these algorithms differ, leading them to react differently when calculating global peak power. The tracking performance of the aforementioned technique is enhanced by selecting the appropriate duty cycle, dynamic perturbation step size, and current parameter. The difficulty of monitoring the worldwide peak as sun irradiance and temperature vary is addressed by this method. This paper presents a unique Hybrid MPPT model that combines the Reinforcement Learning (RL) algorithm with the Perturb & Observe approach to maximise electricity from photovoltaic fixed overheads in response to fluctuations in sun irradiance and partial shadowing. RL performs the first phases of maximum power point tracking in order to provide a more accurate estimate of the global peak, which contributes to the overall stage selection of the P & O technique. This strategy might be useful for reducing the effects of partial shade. The proposed approach is tested on a PV array under a range of partial shade circumstances. The efficiency of the proposed approach is assessed by comparing it to conventional P & O using the MATLAB/SIMULINK tool. The examination found that the proposed MPPT controller provides a 10% gain in tracking efficiency over the typical P&O MPPT approach in even the most demanding scenarios.

Keywords: Reinforcement Learning, MPPT, AI, Perturb & Observe

### I. INTRODUCTION:

The effectiveness by which a country's power supply is delivered is essential to the country's economic growth. Due to a scarcity of fossil resources, nonconventional energy sources are utilised. Solar energy is an excellent nonconventional energy source that may be used to generate electricity using photovoltaic modules. Because of its environmental advantages, minimal maintenance, and lack

of noise, photovoltaic (PV) power production is swiftly becoming one of the most popular renewable energy sources. MPPT efficiency is a critical component of all PV systems. The success of these renewable energy sources may be attributed to innovative technology, enhanced control topologies, new devices, and an effective management system. Maximum power is difficult to monitor due to the PV curve's non-linear I-V characteristics. A multitude of variables impact PV module performance, including variations in sun irradiation, temperature fluctuations, and partial shadowing circumstances. In India, rural electrification began in the 1950s having the goal of fostering economic development and enhancing rural living life. Photovoltaic systems, which produce clean energy directly from the sun, have the potential to benefit the home, medical services, farming, educational, and commercial sectors. Photovoltaic power has the ability to electrify every part of the world in the contemporary age. [1] Any PV array in a PV system is made up of numerous PV panels linked in series or parallel to provide high voltage and significant current with the goal to maximise the output power of the PV array. A solar power system has two kinds of diodes: bypass diodes and blocking diodes, both of that serves a distinct function. Electricity backflow is prevented by using blocking diodes. Bypass diodes are utilised to prevent power loss caused by shadowing as well as hotspot heating. PSC occurs when each panel receives and experiences varied quantities of solar irradiation and temperature approximately the same time. PSCs cause many peaks in a PV array's P-V (power-voltage) characteristic curve. There is going to be only one global maximum power point among all the peaks, and the rest are known as local maximum power points. Maximum power point tracking is critical in a photovoltaic (PV) array-based energy conversion system. PV arrays in partial shadow have several local peak power points, resulting in a nonlinear P-V characteristic with many distinct maximum power points, making existing maximum power point tracking methods ineffectual, if not incorrect.

Partial shading in a PV array happens when some of the PV modules (array) are shaded by adjacent buildings, birds, trees, and power poles, among other things, while other areas get steady sun irradiation. As a consequence of this condition, the module has a hot spot issue. To solve this issue, bypass diodes are utilised. It is responsible for changes in solar irradiance and temperature. When the sun shines strongly, it's easy to get the maximum power out of a PV module. The PV array, on the other hand, creates many peaks in non-uniform circumstances. It's tough to isolate a single worldwide peak from it. As a consequence, determining the precise maximum power point (MPP) has always been challenging. PV arrays that are subjected to non-uniform solar irradiation, such as partial shade, struggle to capture the maximum amount of power. Hill climbing, P&O, Incremental Conductance, and other MPPTs have previously been presented [2]- [5]. The effects of perturbation rate and step size on system behaviour were explored. With reference voltage perturbation, the system reacts to irradiance and temperature transients more quickly. Reducing the perturbation step size can lessen oscillation, however a smaller perturbation step size slows MPP tracking. The steady-state oscillations are increased when the perturbation rate is large. Kollimalla and Mishra created a variable perturbation step size MPPT strategy to improve the performance of the P & O technique [6]. A lot of publications researched the P & O algorithm. When the sun shines evenly, they are often employed to get the most power from a PV module. However, these solutions did not account for partial shadowing conditions or the stochastic nature of solar irradiation. Under non-uniform solar irradiation, many MPPs appear in the PV module's power-voltage characteristic. Finding a global peak amid several peaks is difficult. It is possible to get a local peak while receiving less power from the PV module. Several academics are now working to identify the exact global peak under partial shade conditions. Many optimisation tactics are used to obtain the maximum power out of a partly shaded PV array.

## II. LITERATURE REVIEW:

The Power-Voltage characteristics of the PV array indicate the presence of partial shade [7]. Many scholars provide a thorough examination of MPPT approaches [8]-[9]. The P and O algorithm is one of the most often used traditional MPPT algorithms due to its ease of usage. However, it suffers from problems like as steady-state oscillation, tracking direction changes, and tracking efficiency [10]. The majority of the researches [11]-[15] worked on modified versions of traditional P & O MPPT approaches. Many advanced MPPT algorithms, as well as a wide range of other evolutionary algorithms, have recently developed MPPT techniques to track the global peak for PSCs. These algorithms are prone to get caught at a local peak, resulting in significant power loss. To solve this constraint of standard MPPT approaches, optimization-based MPPT strategies such as PSO [7], grey wolf optimisation (GWO) [16]-[17], cuckoo search (CS) [18], jaya algorithm (JA) [19], and artificial bee colony (ABC) [20] have been developed. The MPPT computer programme thoroughly explores the full search space (i.e. the module's Power-Voltage curve). These solutions handle the issue of partial shading, but they increase computing complexity. To improve MPP convergence, modified versions of optimisation approaches are offered. Kashif Ishaque and Zainal Salam developed deterministic particle swarm optimisation to improve solar system tracking in partial shadowing conditions. The random number throughout the accelerations element of the PSO velocity equation is eliminated using this approach, which overcomes the shortcoming of PSO. Furthermore, the largest change in velocity,  $V_{max}$ , is restricted to a certain value that will be determined after a comprehensive investigation of P-V characteristics during partial shading [21]. Similarly, Hong Li et al. suggested Overall Distribution Particle Swarm Optimisation, a modified version of the PSO MPPT technique. Despite having no specific knowledge of the PV array, our technique may rapidly identify the little area containing the GMPP, resulting in a fast MPPT speed [22]. Modified versions of classic MPPTs are also proposed [23]-[28]. However, improving the performance of PV systems continues to be a problem. According to various academic papers [29], a suitable MPPT algorithm under partial shading conditions, including the impacts of temperature and solar irradiation, is necessary to monitor the right global peak from the PV array.

Chen et al. [30] developed a novel approach for tracking the global maximum power point of PV, which has the benefits of detecting partial shadow, calculating the number of peaks on P-V curves, and forecasting maximum power point locations. The new method may rapidly identify the highest power point and save a significant amount of energy that would normally be lost due to random scanning. H. Li et al. [31] provide a novel overall distribution MPPT technique for swiftly scanning the area around global maximum power points, which is then combined with the particle swarm optimisation MPPT tool to improve MPPT accuracy. Ahmed et al. [32] provide a precise detection method for distinguishing partial shadowing from uniform irradiance variation. As a consequence, it eliminates the unnecessary global peak search, which has an impact on the efficiency of the maximum power point tracker (MPPT). Detection is enabled by calculating the irradiance at two locations on the I-V curve, such as the short-circuit and MPP currents. To cope with partial shading, some scholars developed global maximum power point tracking methods. [33] demonstrates that the peaks follow a certain process in which the power at a peak point climbs until it reaches the GMPP, at which point it constantly drops. The approach proposed in [34] includes continuous current measurement as well as periodic pauses to handle unique challenges such as quickly changing insolation or partial shade. The first and second derivative products of power as a function of duty-cycle are used to construct a modified strategy for updating the duty-cycle. [35] proposes a clever P-I curve search approach for locating global maxima. The global MPP is measured in [36] using a dc-dc converter supplied by a changing DC source. Following that, the perturb and observe MPPT technique is utilised to continually monitor the short-term fluctuations of the previously established global MPP. [37] describes a novel model-based two-loop control technique for a module-integrated

PV and converter system with bidirectional Cuk dc-dc converters functioning as bypass converters and a terminal Cuk boost working as a whole-system power conditioner.

When compared to traditional techniques that do not include diodes, the system may generate more power. Because of the time required to perform this tracking procedure, [38] find local MPPs using a periodic scan sequence of the P-V curve, and PV energy production is lowered. The worldwide MPPT techniques [39]-[40] are based on actual data of the open-circuit voltage or short-circuit current of PV arrays with solar irradiation. Several studies have been conducted to determine the global mpp of PV systems operating under constant irradiation levels. Traditional MPP tracking algorithms include P & O [41]-[42], hill climbing [43]-[44], incremental conductance [45]-[46], short-circuit current, open-circuit voltage, and ripple correlation. The adoption of a basic structure and the quick convergence towards the MPP are the major benefits of these techniques. However, these methods can only create a respectable duty cycle output when a single MPP is connected to the PV system's output. The use of by-pass diodes in the majority of modern PV modules raises the risk of partial shadowing. Multiple peaks at the output power-voltage locus are the most typical result of these situations. Conventional techniques fail to identify global MPPs from local MPPs when there are several peaks in the output due to PSCs. The previous technique is based on the hill-climbing concept, which states that the operational point should move in the direction of maximum output power [47]. This is the primary cause for the failure. A deep learning solution based on LSTM is presented to address these partial shading difficulties.

### III. SYSTEM DESIGN:

#### a) PV System Modelling:

A single diode model may stand in for a whole PV module.  $I$  is the current that would flow out of a single diode model.

$$I = I_{pv} - I_0 \left[ \exp\left(\frac{V+R_s I}{V_t a}\right) - 1 \right] \quad [1]$$

The amount of current  $I_{pv}$  produced by a PV panel may be expressed as a function of the available light, or irradiance,  $\mathcal{G}$ .

$$I_{pv} = \left(\frac{\mathcal{G}}{\mathcal{G}_0}\right) I_{go} + J_0(T - T_{ref}) \quad [2]$$

Saturation current in a diode, which is determined by temperature, may be expressed as:

$$I_0 = I_{o,n} \left(\frac{T}{T_{ref}}\right)^3 \exp\left[\frac{qE_g}{ak} \left(\frac{T}{T_{ref}} - \frac{1}{T}\right)\right] \quad [3]$$

In the previous section, we defined the terms that are used in equations (1), (2), and (3). As an optimisation problem, the proposed maximum power extraction is as follows:

$$\begin{aligned} & \text{Maximize } (\mathcal{P}(d)) \\ & \text{Subjected to } d_{\min} \leq d \leq d_{\max} \end{aligned}$$

$\mathcal{P}(d)$  represents the power produced by the PV array,  $d$  is the duty ratio of the dc-dc converter, and  $d_{\min}$  and  $d_{\max}$  represent the minimum and maximum values of the duty ratio, 10% and 90%, respectively.

#### b) System Description

Three modules are shown linked in series (3S) in Figure 1(a). As shown in Fig.1(b), the 3S2P layout uses six PV modules linked in two parallel routes, with three modules in series on each line.

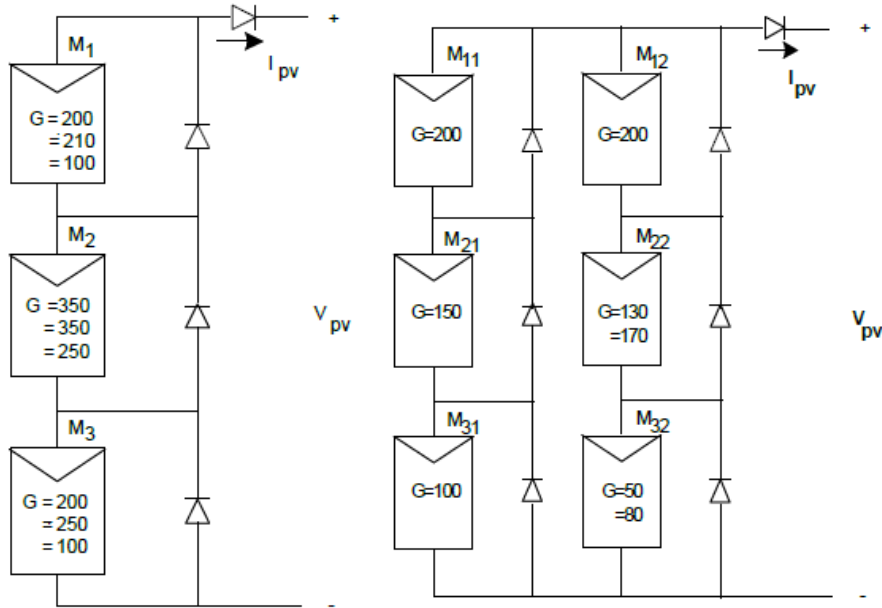

Fig. 1 (a) 3S configuration [48]

(b) 3S2P configuration [48]

The P-V curves of three different shading patterns with easily distinguishable GP sites for the 3S configuration (a) are shown in Figure 2. P-V curves for two alternative 3S2P shadings (b) are shown in Figure 2.

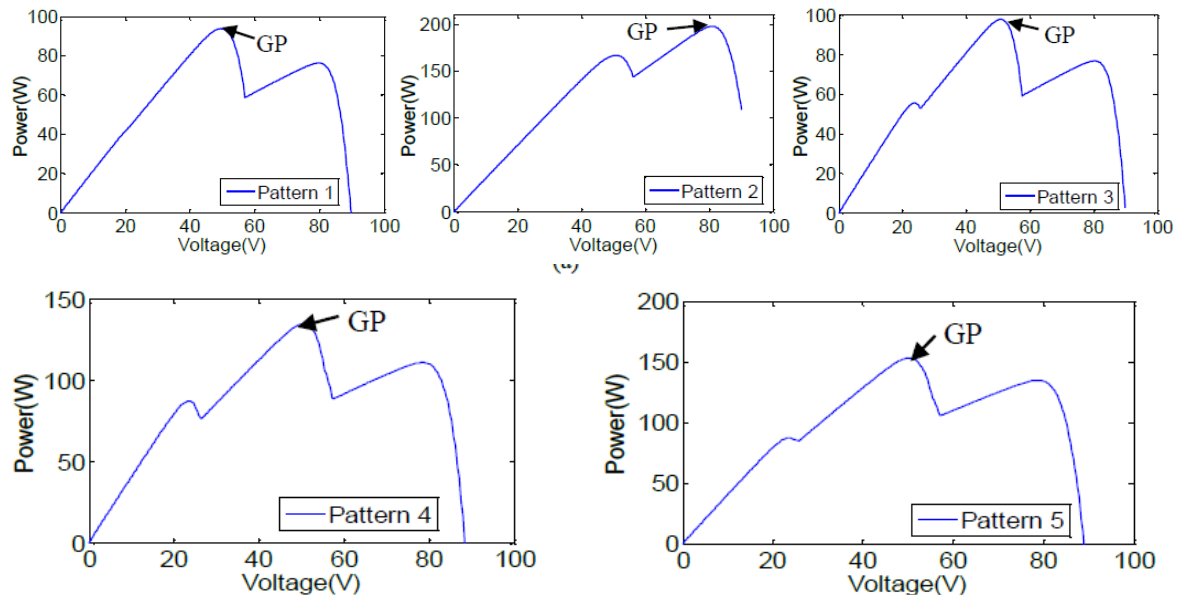

Fig. 2 P-V curves exhibiting multiple peaks[48] (a) 3Sconfiguration (b) 3S2Pconfiguration

*c) Traditional P & O MPPT Technique*

It's a classic MPPT technique that's frequently used. It monitors MPP by comparing the power before and after perturbations. It works by applying a perturbation  $dD$  to the duty cycle 'd' with a

perturbation frequency to calculate power. It begins by calculating the PV array's power by monitoring its voltage and current. The PV power variation ( $dP_{total}$ ) is next checked to see if it is positive or negative. The perturbation will continue in the same direction if  $dP_{total}$  is larger than zero. As illustrated in fig .3. MPP is on the PV curve's left side. If this is not the case, the following disturbance will be in the other direction. The MPP is now on the PV curve's right side. In this approach, the technique keeps track of the real MPP. In steady-state situations, this MPP oscillates. The operational chart of the traditional P&O technique is depicted in fig.4. The MPP is really where the system truly fluctuates. The perturbation step size is decreased in order to reduce oscillations. Small step sizes, on the other hand, slow down MPPT's response. The PV array would have various characteristic curves for varied irradiance and cell temperatures. The primary drawback of this technique is that it causes MPP oscillation under different solar conditions. Obtaining MPP in these circumstances is challenging.

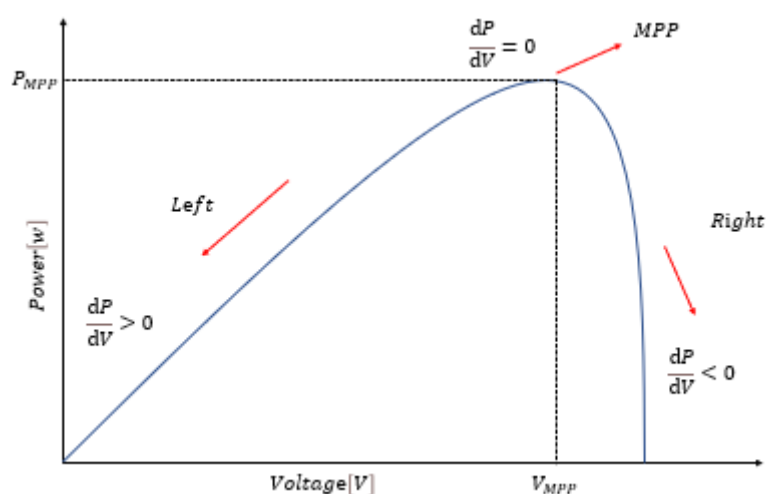

Fig.3 Functional behavior of PV module at MPP

*d) Problems related to Traditional P& O MPPT Algorithm*

*i. Near the MPP ,Oscillation in a steady state*

The PV array's measured voltage (V) and current (I) are utilized to calculate the power (P) in this technique. The operation of this algorithm is based on perturbation in voltage ( $dV_{total}$ ). It is obtained as a result of a power shift. The duty cycle of the converter is indirectly altered by introducing a voltage perturbation. The shift in power determines the direction of the operating point on the P-V curve. The following equation is used to calculate it.

$$D_{new}=D_{old} +dD \text{ (if } dP_{total}>0 \text{ and } dV_{total}<0)$$

$$D_{new}=D_{old} -dD \text{ (if } dP_{total}>0 \text{ and } dV_{total}>0).$$

Using this rule, the direction of perturbation is obtained. Whatever the situation, the PV curve's operating point oscillates about the MPP. This oscillation is shown in fig.3. The size of perturbation decides the speed of MPPT. The oscillation is extremely unfavorable since it causes enormous energy loss. Due to this the new MPPT algorithm is proposed.

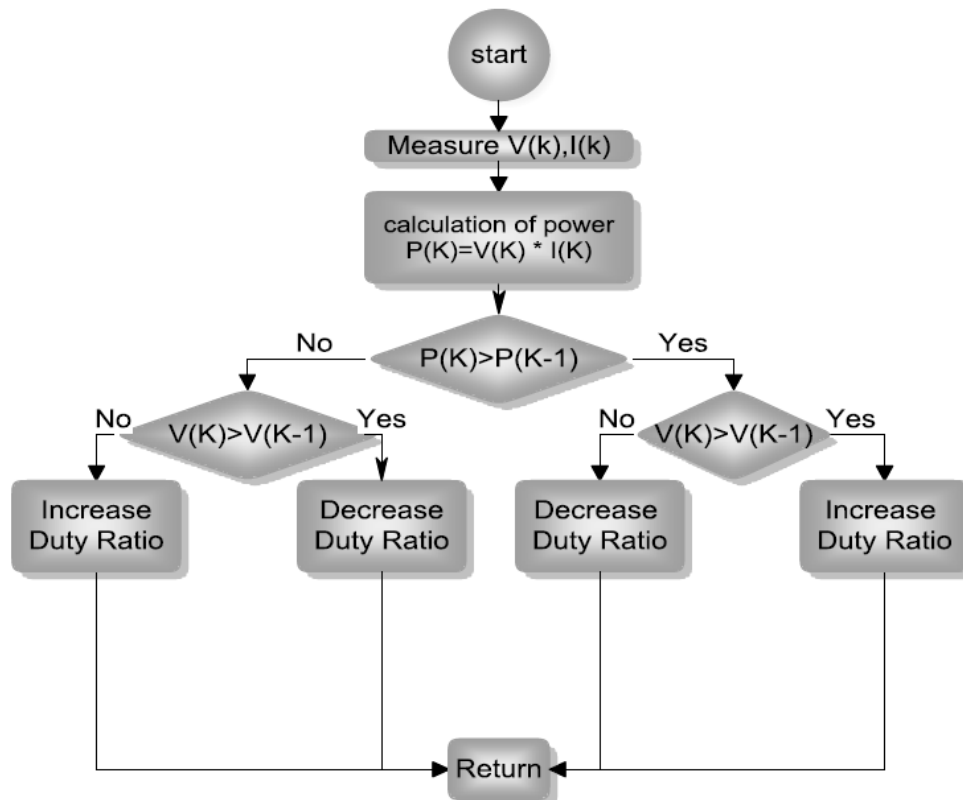

Fig4 Functional chart of traditional P & O MPPT Technique

ii. Deviation from tracking seek vicinity

Apart from the operating point fluctuating from the MPP, P & O also faces the risk of the operating point diverging from its tracking position, that is, deviating from the MPP. A gradual shift in irradiance is frequently the cause of this divergence. Assume that at point P, P & O technique initially follow the MPP, as shown in Fig. 5. As a result, the operating point moves back and forth across P, Q, and Q0 around the MPP. Consider the situation where the irradiance gradually increases as moving closer to P. In the revised irradiation curve (P2 curve), the operational point will become R rather than Q. In this case, the algorithm expects that the perturbation is growing power, so it continues to provide a perturbation in that direction. As a result, as illustrated in Fig.3, the operational point travels away from the MPP, following the route P-R-S. It should be observed that the P-V curve's point R is not MPP ( P2). However, the power at point R is more than the power at point P. As an outcome, the operating point is going to move away from the MPP and will continue to do so as irradiance rises. It's worth noting, too, that the losing of tracking direction occurs only when the solar irradiation steadily increases. The same behaviors do not occur when irradiance declines (at both a slow and fast rate). A successful MPPT algorithm balances tracking rate and steady-state performance. Because the traditional P & O fails to meet these demands, a new MPPT is developed to address these concerns.

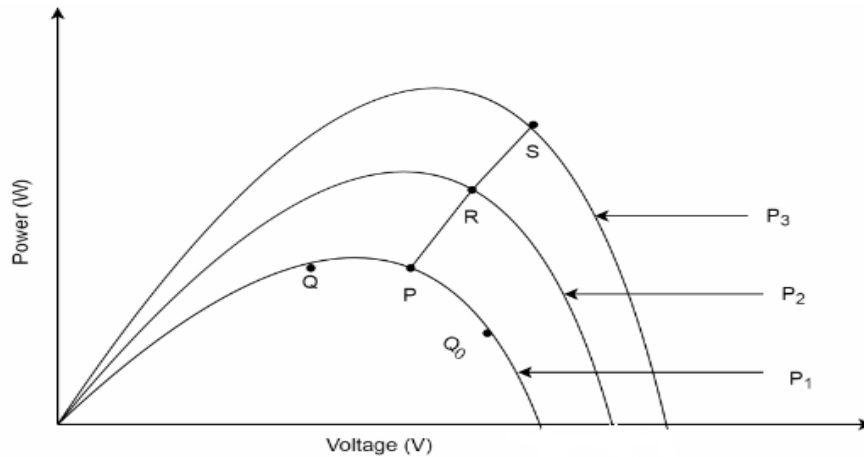

Fig.5 Operation of P & O MPPT Technique

- e) Difficult to identify MPP at partial shaded environment.

Multiple peaks may be seen on the PV array's P-V curve when it is partially shaded. In this circumstances, tracking the worldwide peak is challenging. Improvements to the traditional P & O MPPT technique must be made to offset this disadvantage.

#### IV. PROPOSED METHODOLOGY

To overcome P and O MPPT technique problems, another PV module parameter, the PV module's current, is employed. The photovoltaic current depends upon the solar irradiance  $G$  as well as temperature and it can be written as

$$I_{pv} = \left(\frac{G}{G_{ref}}\right) I_{sc} + k_i(T - T_{ref})$$

Here, the divergence of MPP from its actual position is solved by considering comparison parameters namely the change in current and change in voltage of PV array. The values of these parameters are affected by rapid changes in sun irradiation, temperature variations, and partial shadowing. The change in current is directly proportional to solar irradiance. By incorporating the current parameter of I-V curve, the detection of partial shading condition and sudden change in solar irradiation is observed. When  $dI_{total} > 0$  and  $dV_{total} > 0$  are seen, it indicates that the solar irradiance has changed. The direction of perturbation will be determined by the values of  $dI_{total}$  and  $dV_{total}$ . The operating point divergence problem around the MPP is avoided with this technique, and the partial shading situation's effect is identified. Consider three different scenarios to demonstrate the influence of partial shadowing and a quick shift in solar irradiation on the PV module's Power-Voltage and Current-Voltage curves. The operational point is achieved at point R in the first condition. Measure the PV array's voltage and current and compare it to earlier values. However, if the solar irradiation changes abruptly at point R, the operating point in the new Current-Voltage curve depicted in fig. 6(a) will shift to a new point S. The  $dI_{total}$  and  $dV_{total}$  parameters for a single irradiation can never have the same sign, as illustrated by the Current-Voltage characteristics in Fig. 6(a). Only an increase in irradiation will cause both  $dI_{total}$  and  $dV_{total}$  to be positive. As demonstrated in Fig. 6 (b), both  $dP_{total} > 0$  and  $dV_{total} > 0$  on the Power -Voltage characteristics at point S at the same time. As a result, at point S, all three parameters are positive:  $dP_{total}$ ,  $dV_{total}$ , and  $dI_{total}$ .  $dI_{total}$  and  $dV_{total}$  are now both bigger than 0. It indicates that the solar irradiation has changed abruptly. As demonstrated in Fig. 6(b), the MPP



divergence is solved by the operational point that is closest to MPP. Figure 7 depicts the operational chart of this Ensemble divergence free MPPT algorithm.

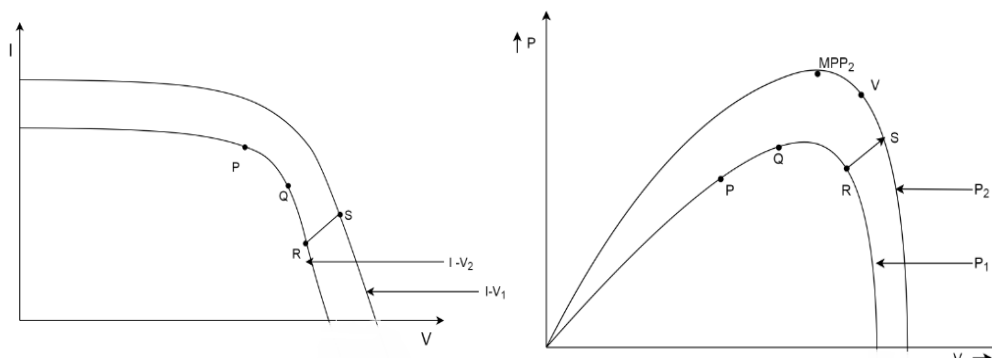

Fig.6 (a) Current -Voltage curve at rapid shift in solar irradiance level Fig.6 (b) Power-Voltage curve at rapid shift in solar irradiance level

#### LSTM:

The standard sequence network's flaw is addressed by adding three gates to each cell of the network to facilitate the idea of memory. A memory is stored and refreshed as the cell receives inputs at each period. forget (f), input I memory (c), and output (o)

Given an old memory  $C_{t-1}$  and a new cell memory  $C_t$ , the new cell memory  $C_t$  is calculated as follows:

$$C_t = f_t * C_{t-1} + i_t * \tilde{C}_t \quad [4]$$

The forget gate selects the information to be erased from working memory.

$$f_t = \sigma(W_f x_t + U_f h_{t-1} + b_f) \quad [5]$$

Memory Gate: Using this feature, fresh storage space may be generated.

$$\tilde{C}_t = \tanh(W_c x_t + U_c h_{t-1} + b_c) \quad [6]$$

This gate determines how much information from the competing memory is transferred to the current one.

$$i_t = \sigma(W_i x_t + U_i h_{t-1} + b_i) \quad [7]$$

The extent to which a cell's memory is recovered is determined by its output gate.

$$o_t = \sigma(W_o x_t + U_o h_{t-1} + b_o) \quad [8]$$

To be specific, we use the MSE as the loss function.

$$\mathcal{L}[Y; \Theta] = \|X - \mathcal{F}[Y]\|_2^2 \quad [9]$$

where  $\|\cdot\|_2$  denotes the  $\ell_2$  norm and  $\Theta$  represents the model  $\mathcal{F}$  parameters that are learned during training.

where  $\|\cdot\|_2$  indicates the  $\ell_2$  norm and  $\Theta$  stands for the trained model  $\mathcal{F}$  parameters.

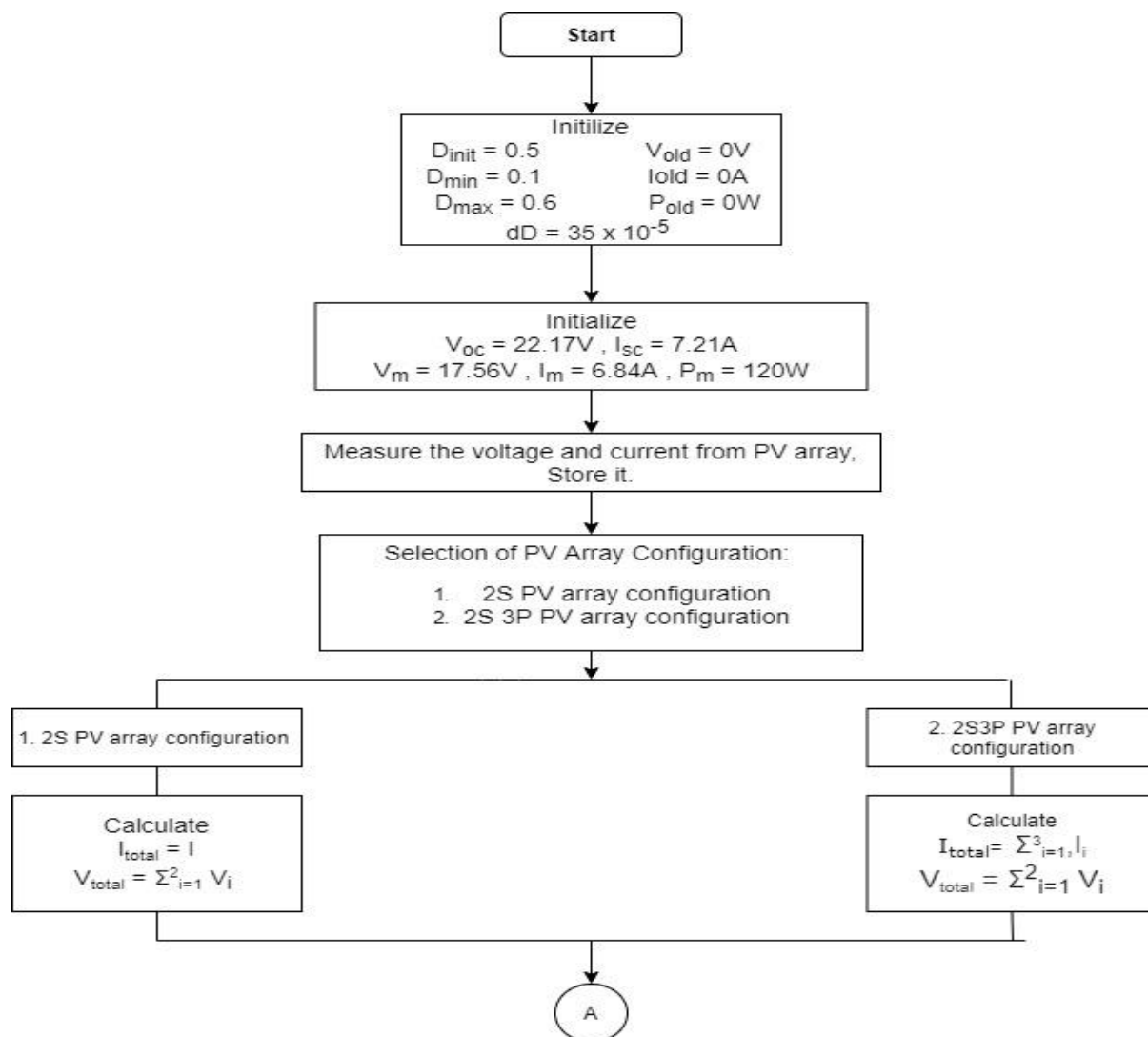

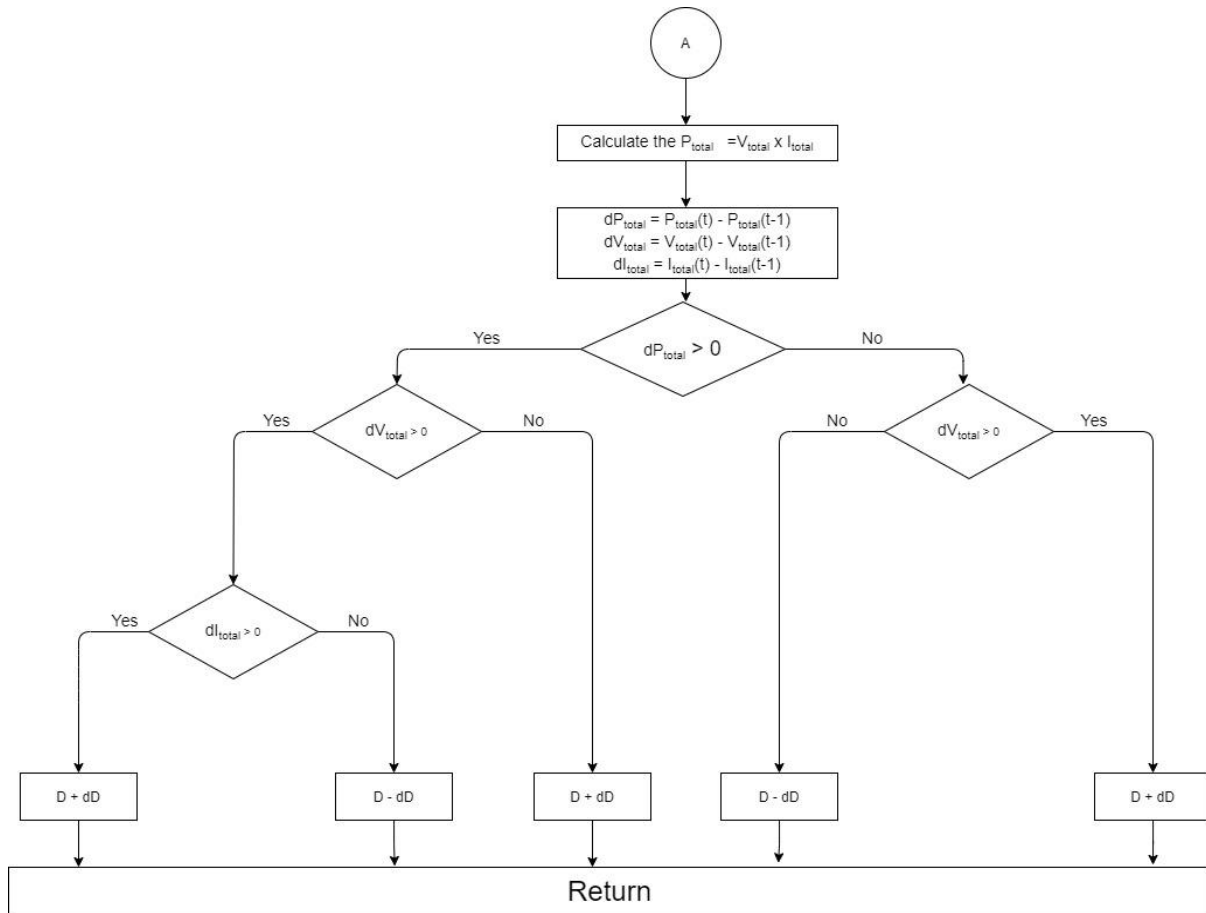

Fig.7 Operational chart of Ensemble divergence free MPPT algorithm

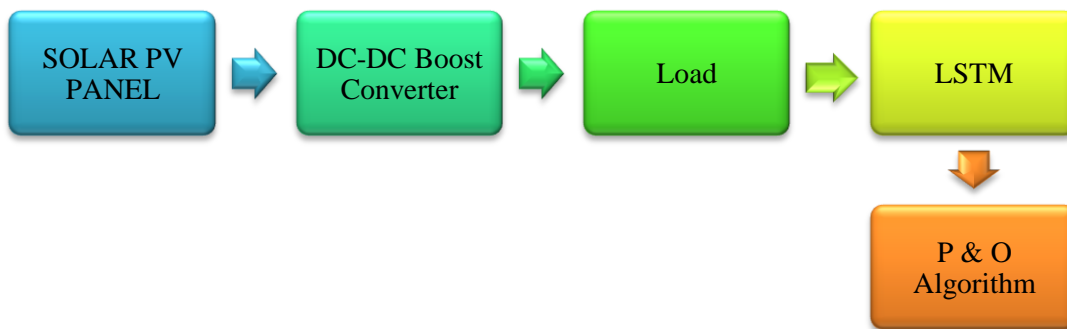

Fig.8 Structure of the propose RL based LSTM- MPPT technique

**V. EXPERIMENTAL RESULTS:**

To investigate the feasibility of the suggested MPPT technique, simulations were conducted for two PV array topologies: 2S and 2S3P. Partially shaded conditions and varied solar irradiation levels are used to assess performance. For simulation purposes, Table 1 illustrates the technical aspects of the necessary PV model. The boost converter topology is selected for the given system.

### A. Influence of Partial Shading

The proposed MPPT algorithm is sorely tested using two different partial shading patterns. Pattern 3 is first applied to a 2s3P PV array arrangement. The suggested MPPT technique is used to extract maximum power from a 2S3P PV system and monitor the global peak. The time it takes to follow the global peak is measured in seconds. The P and O method is compared to the proposed algorithm. Pattern 4 of the 2S3P PV array arrangement is now the shading pattern. The same approach is used to trace the global peak from a large number of local peaks. Figures 12 and 13 depict simulation findings. In comparison to traditional P & O MPPT, the global peak is tracked relatively quickly in the simulation results. The proposed MPPT algorithm creates fewer oscillations than the P & O method, which is clear.

### B. Rapidly Changing Solar irradiation

In 2S arrangements, the solar irradiation of the PV modules is freely switched from pattern 1 to pattern 2. On 2S and 2S3P PV array topologies, the suggested MPPT and the traditional Perturb and Observe method are used. The global peak is detected in shorter time even if there is a quick shift in solar irradiation levels and maximum power is harvested from it, according to the simulation findings given in figs 14 and 15. The simulation is again conducted for the 3S2P configuration using two distinct patterns, such as pattern 3-4. It is depicted in figs. 9 and 10. It is demonstrated that the suggested MPPT can monitor GP in this solar radiation setting with no oscillations and provides a steady response. As shown in Figures 11 and 12, the suggested MPPT technique converges to the GP quicker than the P & O MPPT, whereas the P & O MPPT oscillates.

### C. Excessive Quickly Changing Irradiation

The PV array (2S and 2S3P) arrangements were affected by severe rapidly changing irradiation conditions such as pattern 2- pattern 4-pattern 5 to demonstrate the longevity of the suggested MPPT technique. Each pattern is responding appropriately. The P and O algorithm clearly monitors the global peak with oscillations, as seen in Fig.6,7,8. By adding fewer oscillations, the suggested MPPT observes the GP in less time. In severe quickly changing irradiation conditions, this MPPT algorithm has a faster GP convergence than the P & O algorithm. It beats the P & O MPPT algorithm in terms of convergence rate to the GP, tracking rate, fewer oscillations, and improved efficiency. Table II summarizes the simulation findings presented in Figures 9,10,11,12 and 13. It can be inferred from the analysis in table II that the suggested MPPT technique outpaces the P & O MPPT technique. Table III also includes a comparative examination of various rapidly converging MPPTs.

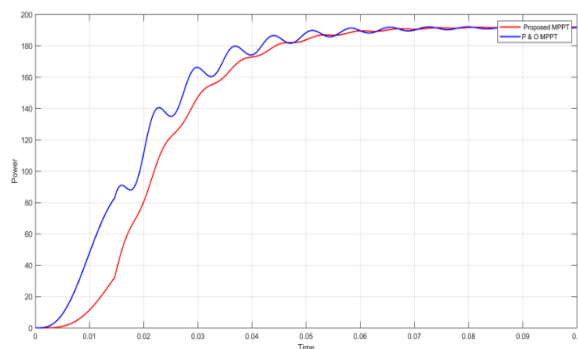

Fig. 9 Pattern 3 curve for 2S3P Configuration

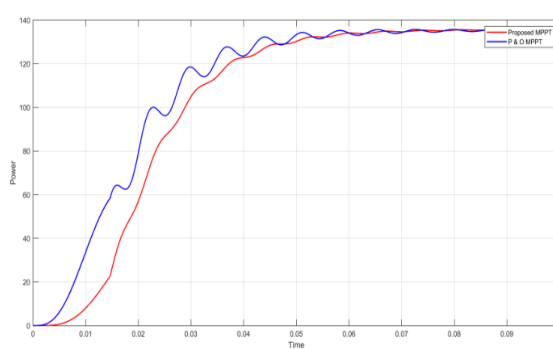

Fig. 10 Pattern 4 curve for 2S3P Configuration

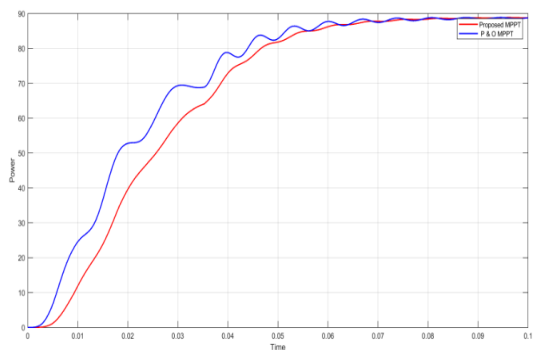

Fig.11 Pattern 5 curve for 2S3P Configuration

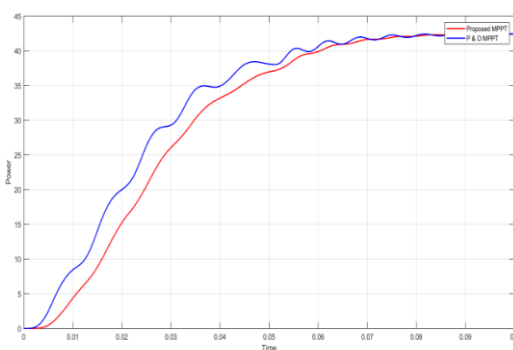

Fig. 12 Pattern 2 curve for 2S Configuration

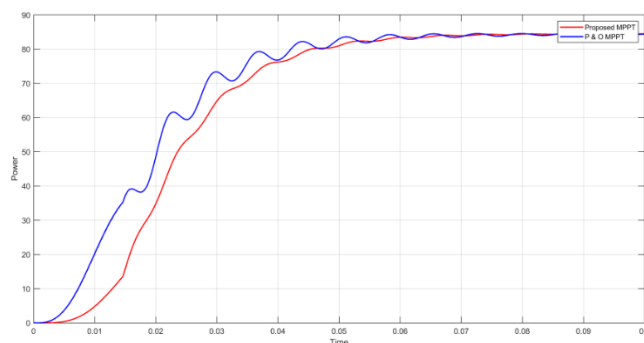

Fig.13 Pattern 1 curve for 2S Configuration

Table I. Technical details of 120W PV module

Parameter	Values
Open- circuit voltage( $V_{oc}$ )	22.17V
Short -Circuit Current( $I_{sc}$ )	7.21A
Voltage at $P_m$ ( $V_m$ )	17.56V
Current at $P_m$ ( $I_m$ )	6.84A
Maximum Power ( $P_m$ )	120.11W
Voltage coefficient( $K_V$ )	-0.35(%/deg.C)
Current coefficient ( $K_I$ )	0.06
No. of cells in series per module	36

Table II. Comparative Analysis Of Proposed MPPT For PV Array Configuration

SHADING PATTERN	MPPT TECHNIQUES	TRACKING TIME(S)	% TRACKING EFFICIENCY (H)
PATTERN 1 (2S)	PROPOSED MPPT	0.060	98.75
	P & O	0.073	98.62
PATTERN 2 (2S)	PROPOSED MPPT	0.073	97.65
	P & O	0.082	97.58
PATTERN 3 (2S3P)	PROPOSED MPPT	0.060	99.46
	P & O	0.072	99.34
PATTERN 4 (2S3P)	PROPOSED MPPT	0.059	99.19
	P & O	0.070	99.05
PATTERN 5 (2S3P)	PROPOSED MPPT	0.069	98.82
	P & O	0.078	98.75

Table III

Comparative Analysis Of MPPT Techniques With The Proposed MPPT Technique In Terms Of Features

Type	P & O [12]	IC [1]	MIC	Proposed MPPT
Dynamic Performance	Poor	Oscillatory	Good	Very Good
Tracking Speed	Slow	Medium	Medium	Fast
Sensed Parameter	$V_{pv}, I_{pv}$	$V_{pv}, I_{pv}$	$V_{pv}, I_{pv}$	$V_{pv}, I_{pv}$
Convergence to GP	Not track exact GP	Yes	Yes	Yes
Power Oscillations	Large	Medium	Medium	Medium
Tracking Efficiency	Low under PSCs	Better	High	High
Implementation Complexity	Low	Medium	Medium	Medium

## II. CONCLUSION

The technological issues in the extensively utilized P&O MPPT algorithm were investigated thoroughly. An ensemble divergence free (EDF) MPPT algorithm has been created to address the traditional P&O MPPT approach's limitations. Furthermore, it precisely detects partial shadowing by continually monitoring the current of the PV array in any worst-case scenario. As a result, it achieves an oscillation-free steady state situation by swiftly tracking the genuine MPP without incurring drift. Furthermore, it does not necessitate a large volume of data. This technique responds to changing environmental circumstances the best. The performance of the EDF technique was tested using a

MATLAB simulation. In addition, the EDF MPPT approach differs from the traditional P&O technique. The results demonstrate that the EDF MPPT beats the traditional P & O technique to the issue of tracking efficiency as well as tracking time in each case. EDF MPPT provides significant rise in tracking efficiency against traditional P & O MPPT algorithm. This study explains how a novel Deep Learning-based PO Hybrid-MPPT was created to extract the most energy possible from a PV system in two different configurations. The proposed DL-PO Hybrid MPPT algorithm was tested virtually on a 600W PV system prototype. In terms of tracking speed and convergence to the Global Peak, the suggested DL-PO Hybrid-MPPT surpasses other fast-converging approaches

#### REFERENCES:

- [1] A. Mohapatra et al., *Renewable and Sustainable Energy Reviews*, Volume 80, 2017, Pages 854-867, ISSN 1364-0321.
- [1] A. Mohapatra et al., *Renewable and Sustainable Energy Reviews*, Volume 80, 2017, Pages 854-867, ISSN 1364-0321.
- [2] Mohammed A. Elgendy, Bashar Zahawi, and David J. Atkinson, "Assessment of the Incremental Conductance Maximum Power Point Tracking Algorithm," *IEEE Trans. on Sustainable Energy*, vol. 4, no. 1, pp. 108-117, Jan 2013.
- [3] S. B. Kjær, "Evaluation of the hill climbing and the incremental conductance, maximum power point trackers for photovoltaic power systems," *IEEE Trans. Energy Conversion*, vol. 27, no. 4, pp. 922-929, Dec. 2012.
- [4] Mohammed A. Elgendy, "Assessment of Perturb and Observe MPPT Algorithm Implementation Techniques for PV Pumping Applications," *IEEE Trans. on Sustainable Energy*, vol. 3, no. 1, pp. 21-33, Jan 2012.
- [5] K. Ishaque and Z. Salam, "A Deterministic Particle Swarm Optimization Maximum Power Point Tracker for Photovoltaic System Under Partial Shading Condition", *IEEE Trans. Industrial Electronics*, vol. 60, no. 8, pp. 3195-3206, Aug. 2013
- [6] S. K. Kollimalla and M. K. Mishra, "Variable perturbation size adaptive P&O MPPT algorithm for sudden changes in irradiance," *Sustainable Energy, IEEE Transactions on*, vol. 5, no. 3, pp. 718- 728, 2014.
- [7] Hiren Patel and Vivek Agarwal, "MATLAB-Based Modeling to Study the Effects of Partial Shading on PV Array Characteristics," *IEEE Trans. Energy Conversion*, Vol. 23, No. 1, March 2008.
- [8] B. Subudhi and R. Pradhan, "A Comparative Study on Maximum Power Point Tracking Techniques for Photovoltaic Power Systems," *IEEE Trans. on Sustainable Energy*, vol. 4, no. 1, pp. 89-98, , Jan. 2013
- [9] K. Ishaque and Z. Salam, "A review of maximum power point tracking techniques of PV system for uniform insolation and partial shading condition," *Renewable and Sustainable Energy Reviews*, vol. 19, no. 0, pp. 475-488, 3// 2013.
- [10] J. Ahmed and Z. Salam, "An improved perturb and observe (P&O) maximum power point tracking (MPPT) algorithm for higher efficiency," *Applied Energy*, vol. 150, pp. 97-108, 2015.
- [11] J. Ahmed and Z. Salam, "An Accurate Method for MPPT to Detect the Partial Shading Occurrence in a PV System," *IEEE Transactions on Industrial Informatics*, vol. 13, no. 5, pp. 2151-2161, 2017.
- [12] J. Ahmed and Z. Salam, "An Improved Method to Predict the Position of Maximum Power Point During Partial Shading for PV Arrays," *Industrial Informatics, IEEE Transactions on*, vol. 11, no. 6, pp. 1378-1387, 2015.

- [13] Nishant Kumar, Ikhlaiq Hussain, Bhim Singh, Bijaya Ketan Panigrahi, "Framework of Maximum Power Extraction from Solar PV Panel using Self Predictive Perturb and Observe Algorithm," IEEE Trans. Sustainable Energy, 2017.
- [14] J. Ahmed and Z. Salam, "A Modified P&O Maximum Power Point Tracking Method With Reduced Steady-State Oscillation and Improved Tracking Efficiency," IEEE Transactions on Sustainable Energy, vol. 7, pp. 1506-1515, 2016.
- [15] J. Ahmed and Z. Salam, "An improved perturb and observe (P&O) maximum power point tracking (MPPT) algorithm for higher efficiency," Applied Energy, vol. 150, pp. 97-108, 2015.
- [16] S. Mohanty, B. Subudhi and P. K. Ray, "A New MPPT Design Using Grey Wolf Optimization Technique for Photovoltaic System Under Partial Shading Conditions," IEEE Trans. Sustainable Energy, vol. 7, no. 1, pp. 181-188, Jan. 2016.
- [17] S. Mohanty, B. Subudhi and P. K Ray, "A Grey Wolf-Assisted Perturb & Observe MPPT Algorithm for a PV System", IEEE Trans. on Energy Conversion, vol. 32, no. 1, pp. 340-347, March 2017.
- [18] J. Ahmed and Z. Salam, "A Maximum Power Point Tracking (MPPT) for PV system using Cuckoo Search with partial shading capability," Applied Energy, vol. 119, no. 0, pp. 118-130, 4/15/2014.
- [19] N. Kumar, I. ussain, B. Singh and B. Panigrahi, "Rapid MPPT for Uniformly and Partial Shaded PV System by using JayaDE Algorithm in ighly Fluctuating Atmospheric Conditions," IEEE Trans. Industrial Informatics , (Early Access Article) 2017.
- [20] K.Sundareswaran, P. Sankar, P. S. R. Nayak, S. P. Simon, and S. Palani, "Enhanced Energy Output From a PV System Under Partial Shaded Conditions Through Artificial Bee Colony," IEEE Transactions on Sustainable Energy, vol. 6, pp. 198-209, 2015.
- [21] K. Ishaque and Z. Salam, "A Deterministic Particle Swarm Optimization Maximum Power Point Tracker for Photovoltaic System Under Partial Shading Condition", IEEE Trans. Industrial Electronics, vol. 60, no. 8, pp. 3195-3206, Aug. 2013
- [22] Hong Li, Senior Member, IEEE, Duo Yang, Wenzhe Su, Jinhu Lü, Fellow Member, IEEE and Xinghuo Yu, Fellow Member, IEEE, "An Overall Distribution Particle Swarm Optimization MPPT Algorithm for Photovoltaic System under Partial Shading," IEEE Trans. Industrial Electronics, 2018.
- [23] J. Ahmed and Z. Salam, "An improved perturb and observe (P&O) maximum power point tracking (MPPT) algorithm for higher efficiency," Applied Energy, vol. 150, pp. 97-108, 2015.
- [24] J. Ahmed and Z. Salam, "An Accurate Method for MPPT to Detect the Partial Shading Occurrence in a PV System," IEEE Transactions on Industrial Informatics, vol. 13, no. 5, pp. 2151-2161, 2017.
- [25] J. Ahmed and Z. Salam, "An Improved Method to Predict the Position of Maximum Power Point During Partial Shading for PV Arrays," Industrial Informatics, IEEE Transactions on, vol. 11, no. 6, pp. 1378-1387, 2015.
- [26] K. S. Tey and S. Mekhilef, "Modified incremental conductance algorithm for photovoltaic system under partial shading conditions and load variation," IEEE Transactions on Industrial Electronics, vol. 61, no. 10, pp. 5384-5392, 2014.
- [27] S. K. Kollimalla and M. K. Mishra, "Variable perturbation size adaptive P&O MPPT algorithm for sudden changes in irradiance," Sustainable Energy, IEEE Transactions on, vol. 5, no. 3, pp. 718-728, 2014.
- [28] S. K. Kollimalla and M. K. Mishra, "A novel adaptive P&O MPPT algorithm considering sudden changes in the irradiance," Energy Conversion, IEEE Transactions on, vol. 29, no. 3, pp. 602-610, 2014.



- [29] S. Sankar, Madhusmita Mohanty, K. Chandrasekaran, Sishaj P Simon, and Y. R. Sood, "High-Speed Maximum Power Point Tracking Module for PV Systems," *IEEE Trans. Industrial Electronics*, 2018.
- [30] K. Chen et. al., "An Improved MPPT Controller for Photovoltaic Systems Under Partial Shading Conditions," in *IEEE Transactions on Sustainable Energy*, vol. 5, no. 3, pp. 978-985, July 2014.
- [31] H. Li et. al., "An Overall Distribution Particle Swarm Optimization MPPT Algorithm for Photovoltaic Systems Under Partial Shading," in *IEEE Transactions on Industrial Electronics*, vol. 66, no. 1, pp. 265-275, Jan. 2019.
- [32] J. Ahmed et. al., "An Accurate Method for MPPT to Detect the Partial Shading Occurrence in a PV System," in *IEEE Transactions on Industrial Informatics*, vol. 13, no. 5, pp. 2151-2161, Oct. 2017.
- [33] H. Patel et. al., "Maximum power point tracking scheme for PV systems operating under partially shaded conditions," *IEEE Trans. Ind. Electron.*, vol. 55, no. 4, pp. 1689-1698, Apr. 2008.
- [34] A. Zbeeb et. al., "Improved photovoltaic MPPT algorithm adapted for unstable atmospheric conditions and partial shading," in *Proc. Int. Conf. Clean Elect. Power*, Jun. 2009, pp. 320-323.
- [35] S. Kazmi, et.al, "An improved and very efficient MPPT controller for PV systems subjected to rapidly varying atmospheric conditions and partial shading," in *Proc. Australas. Univ. Power Eng. Conf.*, Sep. 2009, pp. 1-6.
- [36] E. Koutroulis et.al, "A new technique for tracking the global maximum power point of PV arrays operating under partial-shading conditions," *IEEE J. Photovoltaics*, vol. 2, no. 2, pp. 184-190, Apr. 2012.
- [37] B. V. P. Chong et al., "Controller design for integrated PV converter modules under partial shading conditions," *Solar Energy*, vol. 92, pp. 123-138, 2013.
- [38] M. Trova, "Top 5 performers in PHOTON inverter tests," in *Proc. Photon's 1st PV Inverter Conf.*, Stuttgart, Germany, Apr. 2010.
- [39] M. Lei et. al., "A high performance MPPT control method," in *Proc. Int. Conf. Mater. Renew. Energy Environ.*, 2011, vol. 1, pp. 195-199.
- [40] S. Kazmi et.al., "An improved and very efficient MPPT controller for PV systems subjected to rapidly varying atmospheric conditions and partial shading," in *Proc. Australas. Univ. Power Eng. Conf.*, 2009, pp. 1-6.
- [41] Hussein et.al, "Maximum photo voltaic power tracking: an algorithm for rapidly changing atmospheric conditions". *Proc Gener Transm Distrib* 1995;142:59-64. *IEE Proc Gener Transm Distrib* 1995;142:59-64.
- [42] Hua C, et.al., "Implementation of a DSP-controlled photovoltaic system with peak power tracking". *IEEE Transactions on Industrial Electronics*, vol. 45, pp. 99-107, 1998.
- [43] Ma L, et.al. "A high performance MPPT control method". *Mater Renew Energy Environ (ICMREE)* 2011:195-9. *Mater Renew Energy Environ (ICMREE)* 2011:195-9.
- [44] Ahmed et.al., "Perturbation parameters design for hill climbing MPPT techniques". *Ind Electron (ISIE)* 2012:1819-24.
- [45] Tey et. al. "A fast-converging MPPT technique for photovoltaic systems under fast-varying solar irradiation and load resistance." *IEEE Transactions on Industrial Informatics* 2015;11:176-86.
- [46] Tey et al., "Modified incremental conductance MPPT algorithm to mitigate inaccurate responses under rapidly changing solar irradiation level," *Solar Energy* 2014;101:333-42.
- [47] Yi-Hwa et.al, "A particle swarm optimization-based maximum power point tracking algorithm for PV systems operating under partially shaded conditions". *IEEE Transactions on Energy Conversion* 2012;27:1027-35.
- [48] S. Mohanty, et.al, "A Grey Wolf-Assisted Perturb & Observe MPPT Algorithm for a PV System," in *IEEE Transactions on Energy Conversion*, vol. 32, no. 1, pp. 340-347, March 2017.

Mrs. Aarti S. Pawar received her Bachelor's degree (B.E) in Electronics & Communication in 2000 from Pune university. Then she obtained her Master's degree with specialization in Digital Electronics in 2008 from Amravati University. She is pursuing her Doctorate degree from Savitribai Phule Pune university. Her research work includes design of MPPT controller and charging profile of energy storage device (battery) for various applications. She has more than 17 years of teaching experience and currently she is working as Assistant Professor at Pimpri Chinchwad College of Engineering affiliated to Savitribai Phule Pune University, Pune. Her research interests and specialization include Renewable Energy, Power electronics, and Embedded system design. She has more than 11 research papers in reputed international journals and conferences to her credit.



Dr. Mahesh T Kolte received his Bachelor's degree in Electronics Engineering from SGGS College of Engineering, Nanded, Marathwada University. Then he obtained his Master's degree in 2000 and PhD in Electronics and Telecommunication Engineering both from Amravati University, Maharashtra in 2007. Currently he is Professor and Head at Electronics and Telecommunication Engineering, Pimpri Chinchwad College of Engineering, Pune, having teaching experience of twenty-eight years. His research interest includes Signal Processing, Speech Signal processing, Image Processing and Embedded Systems. He has to his credit three patents granted in hearing aid domain and four copyrights registered. He has published more than 30 research papers in international journals and conferences of repute. Five candidates have completed their Ph. D work under his guidance.

