



Real-time implementation of cost-effective solar based desalination plant for residential application

Dr. Navaprakash N^{1*}

^{1*}Assistant Professor, Department of Electronics and Communications, Saveetha School of Engineering, SIMATS, Chennai, Tamilnadu. Email: navaprakash.ece@gmail.com

Dr. Poushali Pal²

²Assistant Professor, Translational Research and Professional Leadership Centre (TPLC), Government Engineering College, Barton Hill, Thiruvananthapuram, Kerala.

Email: poushalipal@gecbh.ac.in

Dr. S. Dinakar Raj^{3*}

³Assistant Professor, Department of Electrical and Electronics, Saveetha School of Engineering, SIMATS, Chennai, Tamilnadu. Email: rajdina@gmail.com

***Corresponding Author: Dr. Navaprakash N**

* Assistant Professor, Department of Electronics and Communications, Saveetha School of Engineering, SIMATS, Chennai, Tamilnadu. Email: navaprakash.ece@gmail.com

ABSTRACT

There is growing penetration of renewable energy sources in most of the field and it reflected for the desalination plant also. As we all are aware of the importance of purification of water for drinking and other purposes. Different existing methods of solar water desalination are solar stills, solar diffusion driven desalination solar pond desalination etc. These methods are less affordable due to its high cost. Moreover, in the existing purification method, power consumption will be more and wastage of water also will be there. So, an innovative and novel solution is implemented in this work for water purification and production of soft water. This method will work in non-membrane type water purification and it will operate on less power. The water wastage also can be avoided with this method

Keywords: Renewable, Desalination, Solar Still, Soft water, Non-membrane, less power

1.0 Introduction

With the increase of domestic and industrial purpose of water as resource, sustainable and effective reuse method is necessary, one of the solutions to this leading problem is brackish water desalination as an alternative source of portable water [1]. There are already other techniques present to produce the portable water, they use coal, gas and oil for the functioning of the system, which led to the damage of the environment such as global warming and greenhouse gas emissions [2]. Hence a safer and effective resource should be used like solar energy, the desalination units powered by solar energy are not only eco-friendly but also considered as the simplest, financially affordable since it needs only the sunlight energy from the sun [3]. Even after all this positive points, disadvantages cannot be ignored of using solar energy because of the lower productivity when compared with the other techniques [4].

Worldwide number of techniques are used for the sea water desalination, which were developed to supply fresh water in dry areas around the world. Most commonly used commercial purpose techniques are thermal and membrane methods [5]. Multi-effect desalination technique provides a considerable quantity of portable water hence used commonly because of its lower energy consumption, low capital, simple geometry and easy operation [6,7]. On the other hand, MED systems have some disadvantages that includes complex structure and high maintenance and operation cost [8]. But MED is proved to be more suitable desalination process to be driven by solar thermal collectors for medium to high-capacity range

[9]. This technique requires an external source of heat which can be designed to deliver by solar thermal collectors such as concentrating solar power, flat plate collectors and evacuated tube collectors [9].

A study was conducted for the design and functionality of a portable hemispherical solar still [10]. The result showed the range of the output produced from the stills. Normally in solar stills, through convection and radiation the heat of condensation is transferred from the top cover to the atmosphere. But the loss from here is small which leads to a high cover temperature. The effect of water flow using a simple solar still was also investigated during a typical summer day [11]. A theoretical investigation of the solar still performance was carried out with the flowing water as a film over the cover of a single-glass solar still [12, 13]. The conclusion from the study was with a different variation in film cooling parameters, the efficiency of Solar still can be increased around 20% comparing with that of the evaporation from the film and 6% without considering the evaporation [14].

The existing models of water purification use membrane type of water purification which consumes more power and causes to wastage of water. So, to bridge the research gap, a ultrasonic transducer and solar flat plate collector based water purification method is implemented in this paper. The novelty of the work can be listed as follows:

- The solar powered ultrasonic water purifier provides and effective solution for water purification.
- This device provides consistent purity and has ability to control the hardness of water.
- The solar powered ultrasonic water purifier provides and effective solution for water purification.
- This device provides consistent purity and has ability to control the hardness of water.
- In this research work two-steps water purification is implemented using solar still and ultrasonic atomizer.
- This technique is very suitable for producing fresh water from any kind of brackish water with wide range of hardness.

The whole paper is divided into three sections. In the first section, the theoretical modelling is developed for the solar and ultrasonic transducer based desalination of the water. The second section deals with the simulation of the solar desalination plant with ultrasonic transducer. Simulation is done in MATLAB 2022 environment. Three different scenarios are considered based on the various values of solar irradiation with different inclination angle of solar still and for different value of saline water input which is controlled using flow control valve. The amount of the collected distilled water is calculated for each scenario. The third section is focussed on the result analysis for various scenarios. The water quality parameters such as turbidity and PH value are measured before and after the desalination of the water. The real time implementation of the solar desalination plant is discussed in the fourth section.

2.0 EXPERIMENTATION

Theoretical Modelling

The theoretical modelling of the solar still efficiency can be expressed by the following equation

$$\gamma = h_{ev} (T_b - T_g) / (S * A) \dots \dots \dots (1)$$

Where h_{ev} = heat transfer coefficient

T_b = Temperature of the basin water

T_G = Temperature of the inner glass cover

S= Solar intensity in W/m²

A=Area of the solar still

2.1 MATERIALS & METHODOLOGY

The research work is completed using the following steps as shown in the Figure 1.

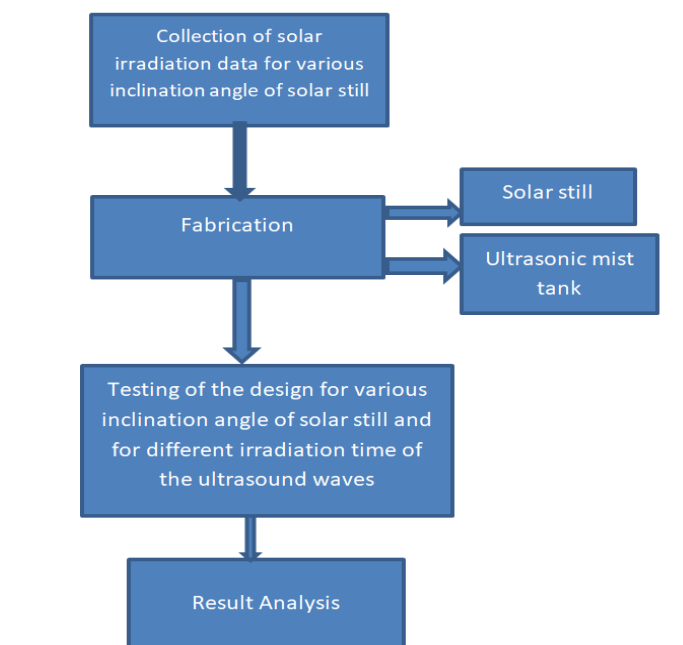

Fig.1 Flowchart of the methodology

2.2 Components and architecture of the model

The detailed architecture of the work is described with the Figure 2. The main components of solar desalination plant can be listed as

- Solar still
- Glass cover
- Condenser
- Basin
- Trough to collect distilled water
- Flexible duct
- Ultrasonic mist maker
- Source tank

- Flow control valve
- Solar panel

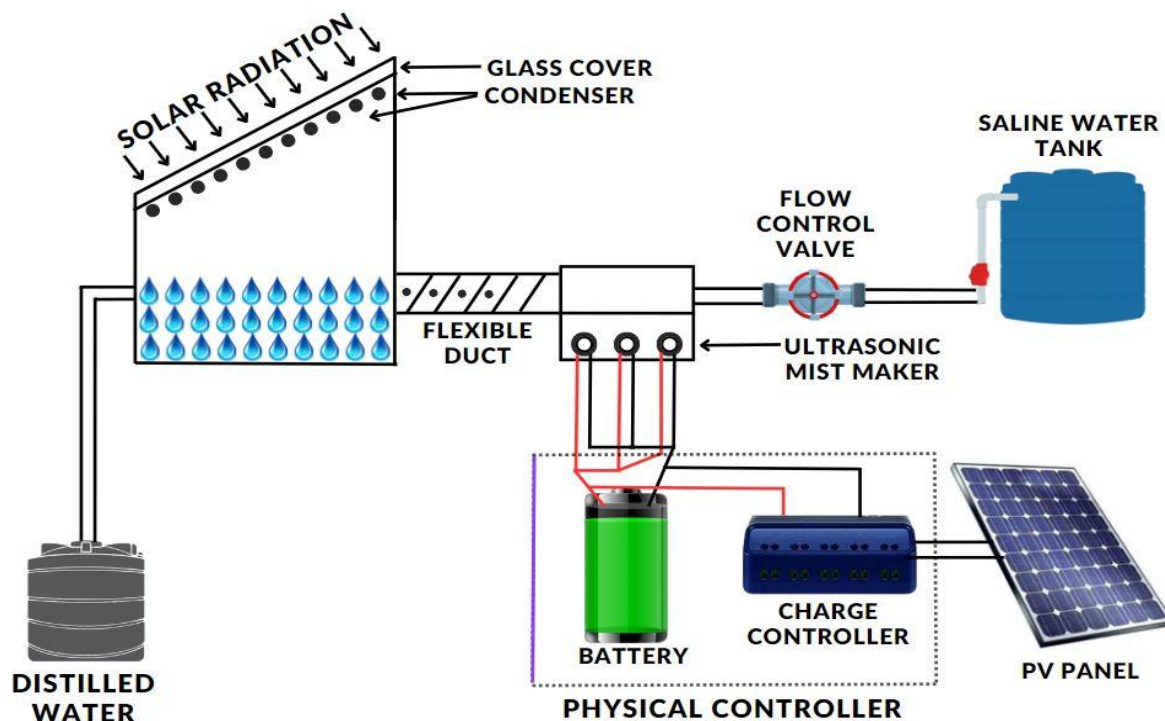

Fig.2 Architecture of the solar desalination plant with ultrasonic transducer

The conventional solar still box has a pool of water at the bottom and the glass cover at the top. The solar insolation is absorbed at the blackened bottom of the pool. It will desalinate the water through evaporation and condensation process by absorbing the solar radiation. The solar radiation will penetrate the glass cover of the solar still, leading to the evaporation of the saline water in the basin through solar radiation absorption.

The ultrasonic mist maker is placed in the source water tank where the saline water is collected using the flow control valve. The ultrasonic atomiser ultrasound will create the cavitation and mist. The mist will move towards the solar still basin through the flexible duct. The desalinated water will be collected in trough after the evaporation and condensation process. In this way the two-step purification of saline or brackish water is implemented in this research work. Application of ultrasonic waves will serve the various purposes such as

- Water disinfection process
- Reduction of turbidity and total suspended solids of the water
- Application of ultrasound for algae removal where the ultrasonication will reduce their capacity to float and by minimising their growth.
- Water softening using the ultrasound waves

3.0 MATLAB SIMULATION

The mathematical modelling of the different components of solar based desalination plant is shown below. The value of the solar irradiation is forecasted for 24 hours and is shown in Figure 3. The ratio of sodium silicate to sodium hydroxide solution was kept constant at 2.5. In this, the mechanical strength properties of the GPC mixes, which were cast with steel fibres containing 1.5%, are examined and given.

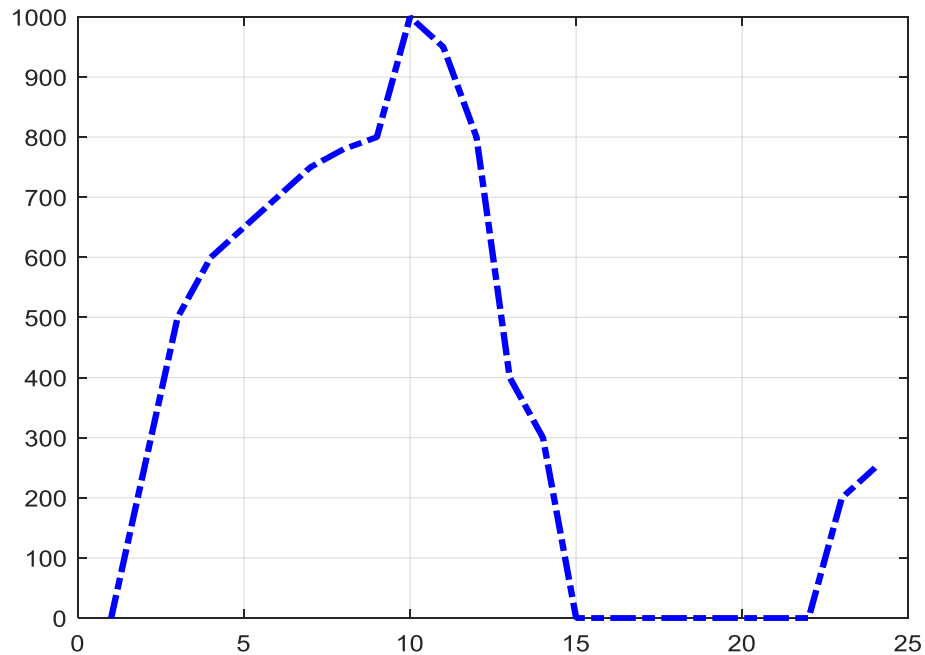

Fig.3 The value of solar irradiation in 24 hours

The Simulink model of the solar still can be described as shown in the Figure 4. The efficiency of the model can be expressed as below. The output of the solar flat plate collector can be described using the following equation

$$P_{out} = f[I_r + (t_{collector} - t_{amb}) + (h_r + h_{cond} + h_{conv})]$$

Where,

P_{out} denotes the power output of the solar still

I_r is the solar irradiation in W/m^2 for the solar still

$t_{collector}$ is the temperature of the solar still

t_{amb} is the ambient temperature

h_r is radiation heat loss

h_{cond} and h_{conv} = heat loss due to conduction and convection

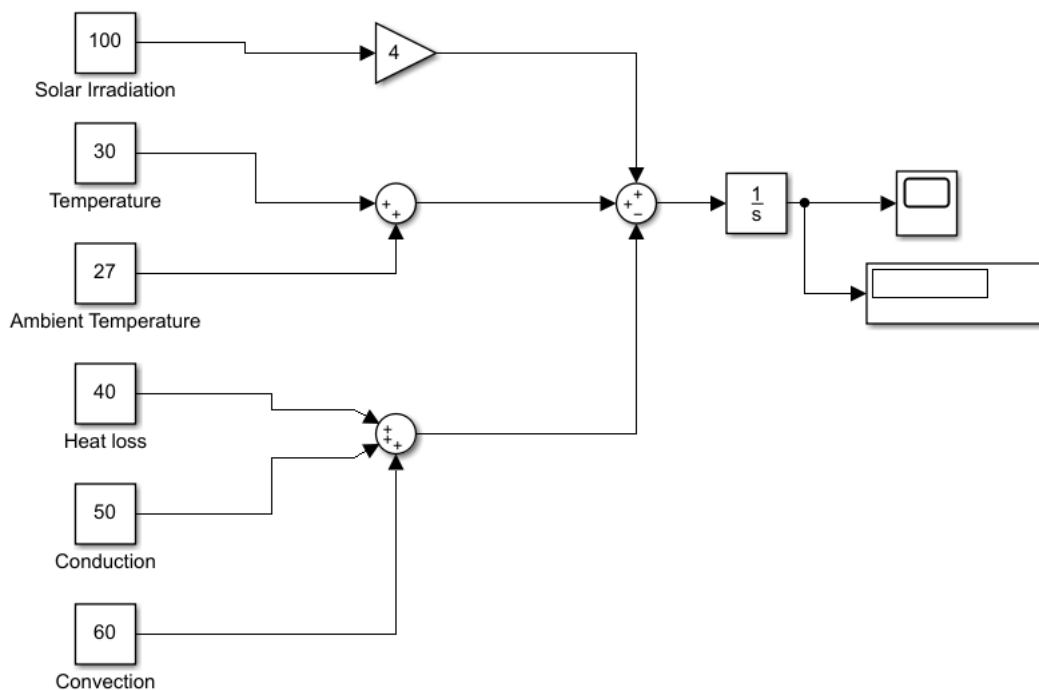

Fig.4 Simulink model for solar still

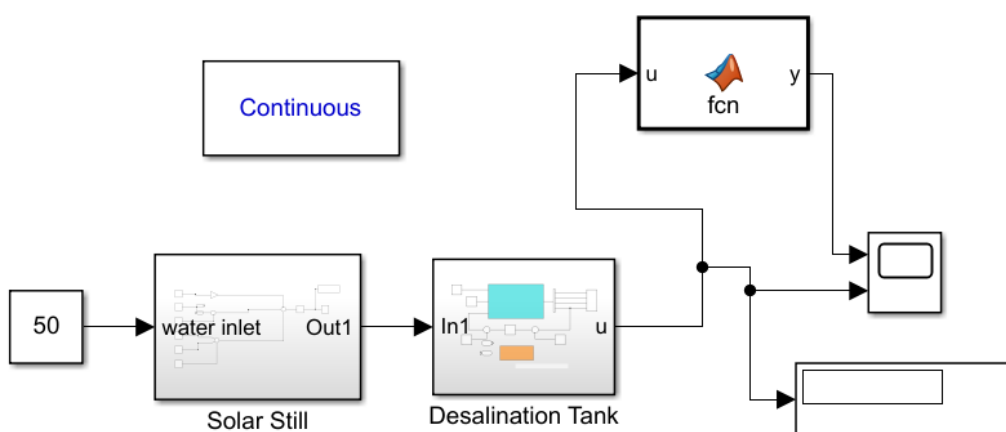

Fig.5 Solar Desalination plant Simulink model

Mathematical The simulation is carried out for three different scenarios. These scenarios are considered depending upon the different values of inclination angle of solar still which will affect the value of solar irradiation. The flow control valve is used for controlling the incoming of saline water. The ultrasound waves work on the destruction of both bacterial cells and organics which are difficult for degradation.

4.0 RESULTS AND DISSCUSSION

The simulation results for the three scenarios are discussed in this section.

First scenario

The first scenario deals with solar still inclination angle of 10° . Solar irradiation value for 10° inclination angle of solar still considered from the literature. Solar irradiation values for 10° inclination angle of solar still are shown in the Figure 6.

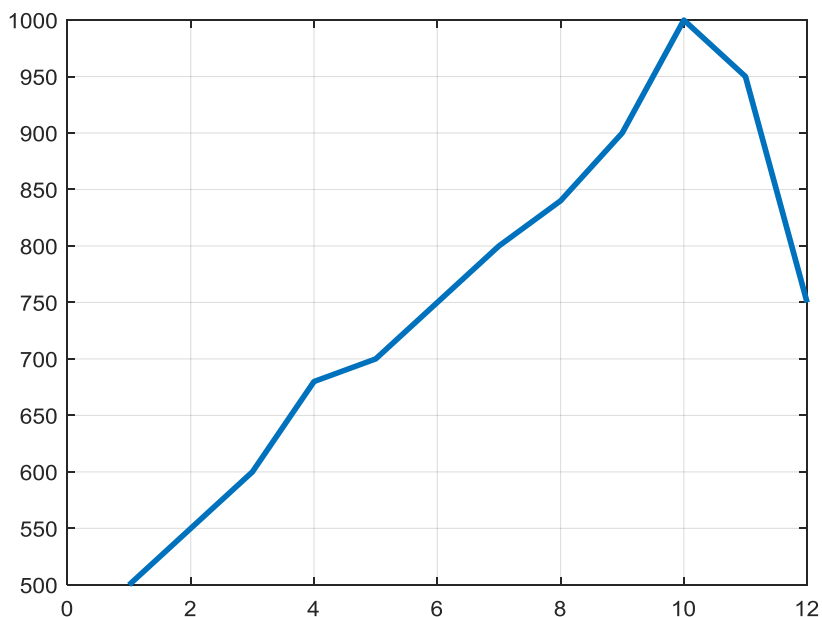

Fig.6 The value of solar irradiation for the inclination angle of 10°

The solar irradiation values have considered based on the different time intervals in day-time. The amount of the purified water collected with the abovementioned inclination angle of solar still is shown in Table 1.

Table1: Amount of desalinated water with solar still inclination angle of 10°

SL. No.	Time in hours	Feed water salinity(ppm)	Salinity level of produced water(ppm)	Volume of the fresh water collected
1.	1	5000	700	160
2.	2	5600	1000	170
3.	3	6000	1200	210
4.	4	6000	1200	210
5.	5	8000	800	160
6.	6	8500	700	170
7.	7	9000	1000	180
8.	8	9000	1000	170
9.	9	10000	1200	160
10.	10	10000	800	170
11.	11	11000	1000	180
12.	12	11500	1200	180

Second scenario

The second scenario deals with the angular inclination of 20°. The value of the solar irradiation for inclination angle of 20° is shown in the Figure 7.

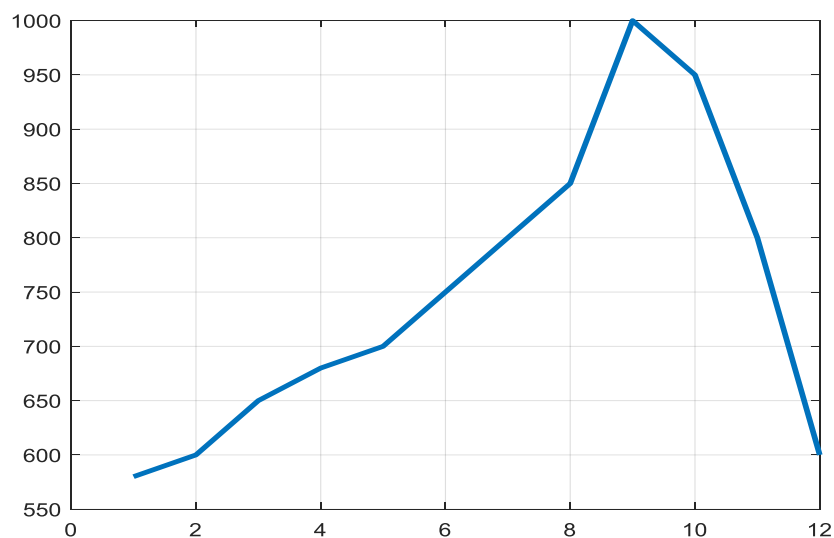

Fig.7 The value of solar irradiation for the inclination angle of 20°

The amount of the purified water at different time intervals of the day is shown in the Table 2.

Table 2: Amount of desalinated water with solar still inclination angle of 20°

Sl. No.	Time in hours	Feed water salinity (ppm)	Salinity level of produced water (ppm)	Volume of the fresh water collected in ml
1.	1	4000	700	190
2.	2	5000	1000	160
3.	3	6000	1200	210
4.	4	6000	1200	180
5.	5	7000	800	160
6.	6	8500	700	170
7.	7	8500	1000	180
8.	8	9000	1000	170
9.	9	9500	1200	160
10.	10	10000	800	170
11.	11	11000	1000	180
12.	12	11500	1200	180

Third scenario

The third scenario is considered for the solar still inclination angle of 30°. The value of the solar irradiation for the solar still inclination angle of 30° is shown in the Figure 8.

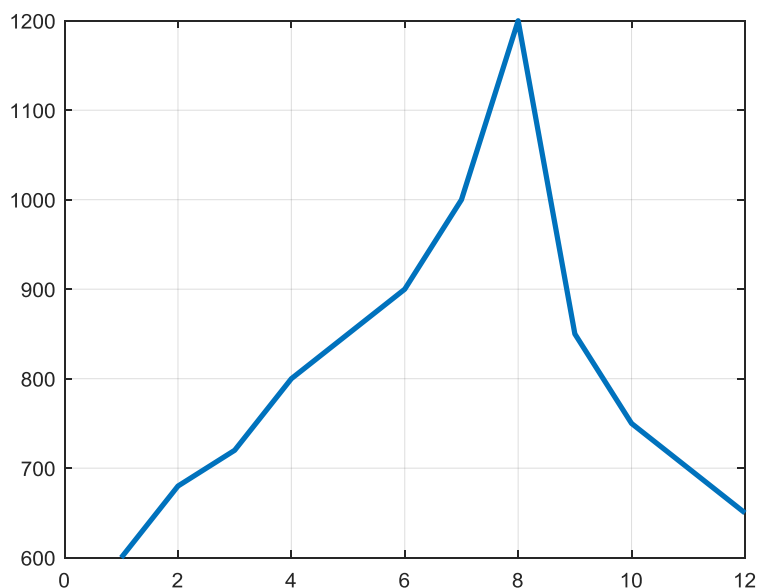

Fig.8 The value of solar irradiation for the inclination angle of 30°

The amount of the purified water with 30° inclination angle of the solar still is shown in the Table 3.

Table 3: Amount of desalinated water with solar still inclination angle of 30°

Sl. No.	Time in hours	Feed water salinity (ppm)	Salinity level of produced water (ppm)	Volume of the fresh water collected in ml
1.	1	4000	500	160
2.	2	5000	700	170
3.	3	6000	800	210
4.	4	6000	700	180
5.	5	7000	750	200
6.	6	8500	700	170
7.	7	8500	800	180
8.	8	9000	750	170
9.	9	9500	600	160
10.	10	10000	800	170
11.	11	11000	900	180
12.	12	11500	1000	180

Comparison of the three scenarios

The comparison of the three scenarios is shown in the Figure 9. The salinity of the feed water and produced water is calculated for the three scenarios and it can be analysed that the salinity of the water is less for the third scenario where the inclination angle of the solar still is 30°.

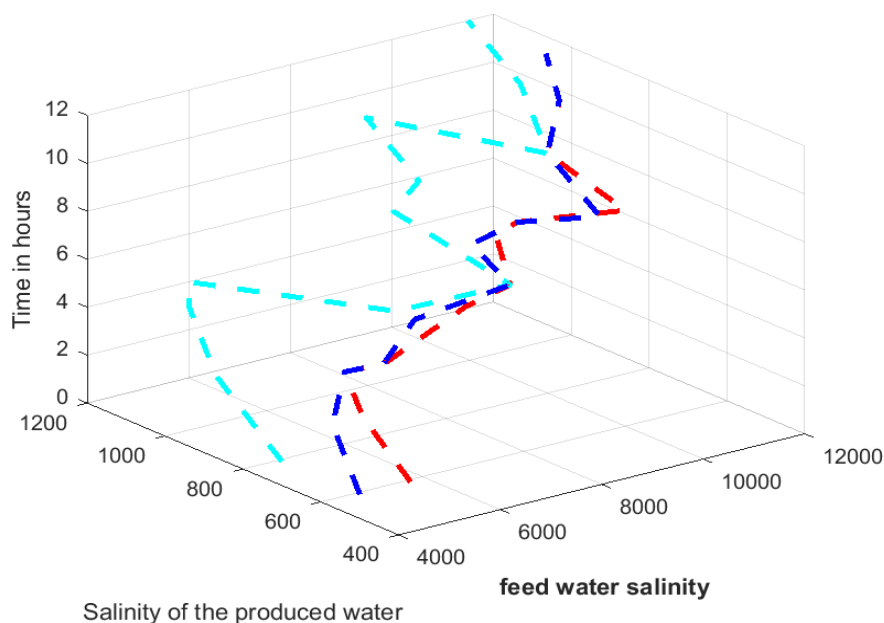





Fig.9 Comparative analysis of Solar based Desalination

5.0 EXPERIMENTAL SETUP

The materials required for the implementation of solar desalination plant is discussed as below

SI No.	Description	Specification
1.	<p>ACRYLIC GLASS</p> <p>Acrylic plexiglass sheets which are thermoplastics, are commonly acquired in sheet form as a lightweight and shatter-resistant substitute for glass.</p>	
2.	<p>ALUMINUM FOIL</p> <p>Aluminium foil is a thin, flat piece of aluminium with many applications. Aluminium foil is measured by its thickness (micron). It is commonly used in the transportation, food and aerospace industry due to its light weight and resistance to corrosion.</p>	 <p>Length: 24inch Breadth: 30 inch Thickness: 18 micron</p>

3.	<p>GLASS</p> <p>Glass frame helps absorb the sun light ray to prevent the heat getting out of the frame. It is attached to the bottom aluminium frame</p>	 <p>Length: 24inch Breadth: 30 inch Material: clear glass Thickness: 10 mm</p>
4.	<p>MIST TANK</p> <ul style="list-style-type: none"> • Ultrasonic Transducer • Blower • Motor speed regulator 	 <p>Input Voltage and current: 24V, 800 mA Evaporation: Upto 350ML/H Working Depth and Temperature: 3-8cm at max 50°C Water Consumption: 80ml/h Mist Diameter: Approx.1.8inch Mist Height: Approx.1.6inch</p>

The fabrication of mist maker tank, solar still, full model of solar desalination plant is shown in the Figure 10, Figure 11, Figure 12 respectively.

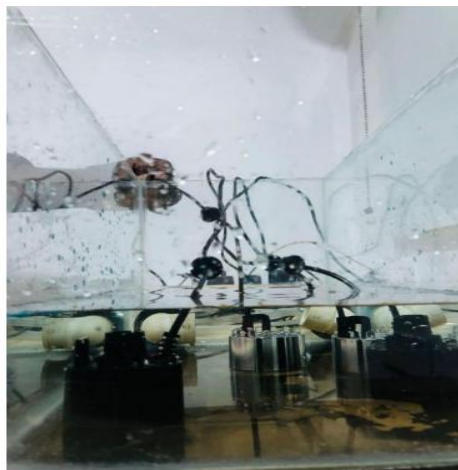

Fig.10 Mist maker Tank



Fig.11 Fabrication of Solar Still



Fig.12 Fully fabricated model of Solar Desalination System

6.0 CONCLUSION

The solar based desalination plant is developed in this paper using solar thermal energy and ultrasonic atomizer. The simulation is carried out for the three scenarios with different values of solar still angle and for different values of solar irradiation. Difference of the salinity between feed water and produced water is calculated for each scenario. The experimental setup of the model is shown in the last section. It can be concluded that the salinity of the water is less for the third scenario with 30° inclination angle of the solar still. Further the detailed research can be carried out for the water quality analysis of the abovementioned scenarios.

References

1. Yadav, S., & Sudhakar, K. (2015). Different domestic designs of solar stills: A review. *Renewable & Sustainable Energy Reviews*, 47, 718–731. <https://doi.org/10.1016/j.rser.2015.03.064>
2. Chandrashekhara, M., & Yadav, A. (2017). Water desalination system using solar heat: A review. *Renewable & Sustainable Energy Reviews*, 67, 1308–1330. <https://doi.org/10.1016/j.rser.2016.08.058>
3. Kabeel, A. E., Abdelgaied, M., Abdelgaied, M., & Eisa, A. (2020). A comprehensive review of tubular solar still designs, performance, and economic analysis. *Journal of Cleaner Production*, 246, 119030. <https://doi.org/10.1016/j.jclepro.2019.119030>
4. Rajaseenivasan, T., Elango, T., & Murugavel, K. K. (2013). Comparative study of double basin and single basin solar stills. *Desalination*, 309, 27–31. <https://doi.org/10.1016/j.desal.2012.09.014>
5. Alsairafi, A. A., Al-Shehaima, I. H., & Darwish, M. (2013). Efficiency improvement and exergy destruction reduction by combining a power and a multi-effect boiling desalination plant. *DOAJ (DOAJ: Directory of Open Access Journals)*. <https://doaj.org/article/94bc56a2bb0145fe991090e87ff8c773>
6. Mazini, M. T., Yazdizadeh, A., & Ramezani, M. (2014). Dynamic modeling of multi-effect desalination with thermal vapor compressor plant. *Desalination*, 353, 98–108. <https://doi.org/10.1016/j.desal.2014.09.014>
7. Al-Mutaz, I. S., & Wazeer, I. (2014). Development of a steady-state mathematical model for MEE-TVC desalination plants. *Desalination*, 351, 9–18. <https://doi.org/10.1016/j.desal.2014.07.018>
8. Zhao, D., Xue, J., Li, S., Sun, H., & Zhang, Q. (2011). Theoretical analyses of thermal and economical aspects of multi-effect distillation desalination dealing with high-salinity wastewater. *Desalination*, 273(2–3), 292–298. <https://doi.org/10.1016/j.desal.2011.01.048>
9. Palenzuela, P., Zaragoza, G., Alarcón, D., & Blanco, J. (2011). Simulation and evaluation of the coupling of desalination units to parabolic-trough solar power plants in the Mediterranean region. *Desalination*, 281, 379–387. <https://doi.org/10.1016/j.desal.2011.08.014>
10. Ismail, B. I. (2009). Design and performance of a transportable hemispherical solar still. *Renewable Energy*, 34(1), 145–150. <https://doi.org/10.1016/j.renene.2008.03.013>
11. Lawrence, S., Gupta, S., & Tiwari, G. (1990). Effect of heat capacity on the performance of solar still with water flow over the glass cover. *Energy Conversion and Management*, 30(3), 277–285. [https://doi.org/10.1016/0196-8904\(90\)90010-v](https://doi.org/10.1016/0196-8904(90)90010-v)
12. Abu-Hijleh, B. (1996). Enhanced solar still performance using water film cooling of the glass cover. *Desalination*, 107(3), 235–244. [https://doi.org/10.1016/s0011-9164\(96\)00165-8](https://doi.org/10.1016/s0011-9164(96)00165-8)

13. Bassam, A., Abu-Hijleh, K., & Mousa, H. (1997). Water film cooling over the glass cover of a solar still including evaporation effects. *Energy*, 22(1), 43–48. [https://doi.org/10.1016/s0360-5442\(96\)00088-6](https://doi.org/10.1016/s0360-5442(96)00088-6)
14. El-Sebaei, A., Trabea, A., & Branch, A. (2005). Estimation of Global Solar Radiation on Horizontal Surfaces Over Egypt. *Egyptian Journal of Solids*, 28(1), 163–175. <https://doi.org/10.21608/ejs.2005.149357>